

Manual

**GM6650/GM6651
Genset controller**

TH132123CR1

The Interpretation of the symbol

**WARNING:**

A WARNING indicates a potentially hazardous situation which, if not avoided, could result in death, or equipment damage.

**NOTE:**

Provide the user's help is very useful information and tips or alert the operator to the correct operation.

History

No.	Rev.	Date	Editor	Validation	Changes
1	TH132123ER1	2017.4	P	C	NEW

**WARNING:**

Read this entire manual pertaining to the work to be performed before installing, operating, or servicing this controller. Practice all plant and safety instructions and precautions. Failure to follow instructions can cause personal injury and/or property damage.

The engine or other type of prime mover should be equipped with an overspeed shutdown device to protect against runaway or damage to the prime mover with possible personal injury, loss of life, or property damage.

The overspeed shutdown device must be totally independent of the prime mover control system. An over temperature or low pressure shutdown device may also be needed for safety, as appropriate.

**WARNING:**

To prevent damage to a controller that uses an alternator or battery-charging device, make sure the power cable of charge or charger and controllers is turned off before disconnecting the battery from the system.

**WARNING:**

Controllers contain static-sensitive parts. Observe the following precautions to prevent damage to these parts.

During installation, care must be taken to prevent static electricity.

**CAUTION:**

The controller comes with the factory settings. As the factory settings may not fully meet the actual user needs, the generator settings must be checked before.

Contents

1	Description	1
2	The Outline Dimension Drawings and Controller Wiring.....	2
3	Panel Operation.....	7
4	Control and Operation Instruction.....	9
5	Measure and display data.....	20
6	Pre-alarm and Shutdown Alarm	21
7	Parameters Setting.....	22
8	Installation Guide	92
9	LCD displays and Menu System	93
10	Technical Specification	99

1 Description

GM6650/GM6651 is a new generation of generator set intelligent controller, using a new form structure, refine and improve the performance of the controller, so that the product fully meet of generator users or professional assembly plants of different types of generator sets , including oil and gas generator sets to open automatic stop control and protection needs.

GM6650 is an Auto Start controller.

GM6651 is an AMF (Automatic mains failure) controller. When the mains fails, generator sets automatically start running, When utility power is restored to normal, the controller switches to mains power and the generator cools down and stops.

Features:

- I True RMS measure of voltage and current
- I Multi-Language menu
- I Large screen dot matrix LCD display
- I The unit maintenance time preset and reminders
- I 4 analog inputs for kinds of optional sensors, measurements show oil pressure, temperature and oil level, parameters also can be configured by user
- I 8 definable control relay output
- I 7 D-input can be defined
- I Manually controlled fuel pump
- I Buttons on control panel are used for selecting control modes, starting and stopping the operating procedure, displaying data and modifying the parameters. LED indicators are used for indicating the operation mode of controller and the running status of Genset, and LCD displays each measuring parameter and status
- I USB communication port, or optional RS485 communication port and PC communication, can read and set the controller operating parameters
- I Optional CANbus communication port, the ECU engine parameters to read and control
- I Through with the terminal pin locked, for ease and convenience to connect, move, maintain and replace the device
- I Calendar and clock
- I 4 event record with clock
- I Startup and shutdown of the scheduled time

2 The Outline Dimension Drawings and Controller Wiring

2.1 Details:

Module Dimensions	W208mm×H160mm
Panel Cutout	W173mm×H125mm
Thickness	D39.5mm

GM6651

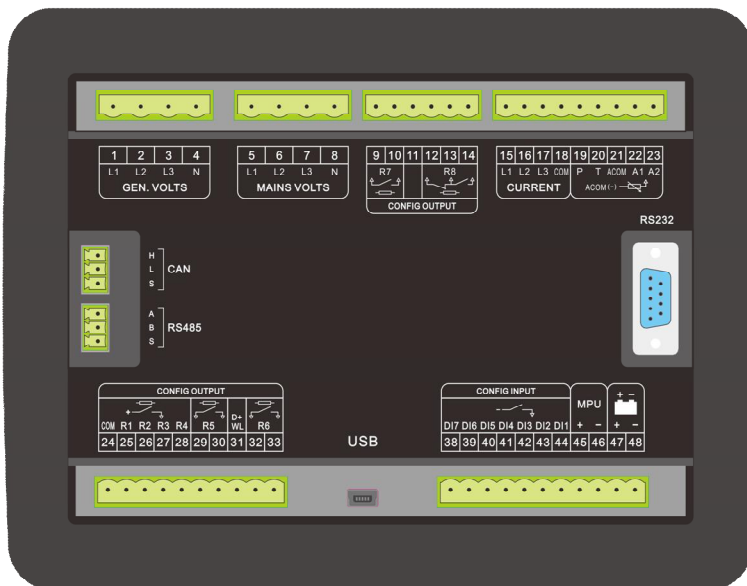
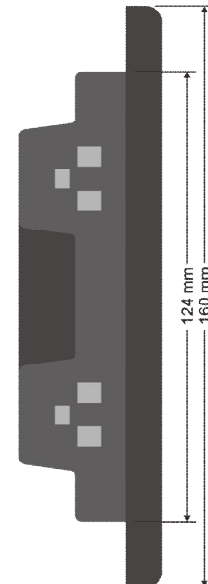
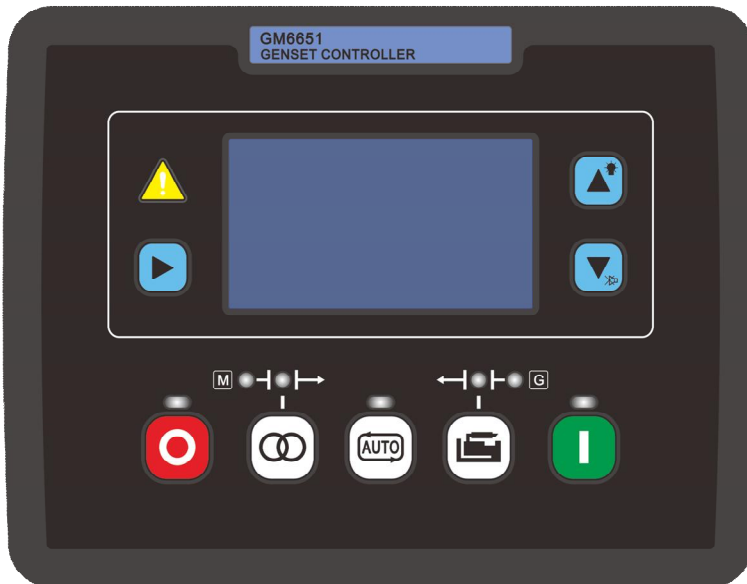
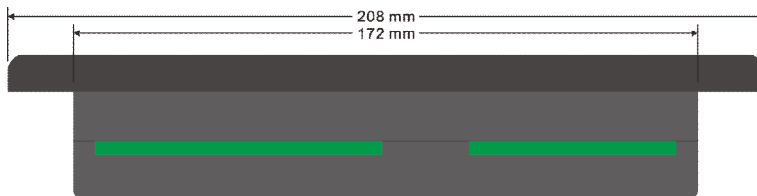

2.2 Terminal Connections:

Pin	Function Description	Signal	Dim
1	GEN. VL1-N input	0-346Vac	1mm ²
2	GEN. VL2-N input	0-346Vac	1mm ²
3	GEN. VL3-N input	0-346Vac	1mm ²
4	GEN. Neutral		1mm ²
5	MAINS VL1-N input	0-346Vac	1mm ²
6	MAINS VL2-N input	0-346Vac	1mm ²
7	MAINS VL3-N input	0-346Vac	1mm ²
8	MAINS Neutral		1mm ²
9	Relay output 7	N.O. contact, 16A/30Vdc, defined (7)	2.5mm ²
10	Relay output 7		2.5mm ²
11	空		
12	Relay output 8	N.C. contact, 16A/30Vdc, defined (8)	2.5mm ²
13	Relay output common point		2.5mm ²
14	Relay output 8	N.O. contact, 16A/30Vdc, defined (8)	2.5mm ²
15	I1 Gen current input (S1)	0-5A	2.5mm ²
16	I2 Gen current input (S1)	0-5A	2.5mm ²
17	I3 Gen current input (S1)	0-5A	2.5mm ²
18	Comm. port for current inputs (S2)	0-5A	2.5mm ²
19	LOP detection	Resistive pressure sensor (<1KΩ)	2.5mm ²
20	HET detection	Resistive temperature sensor	2.5mm ²
21	Sensor common point		2.5mm ²
22	Auxiliary sensor 1	Resistive sensor (<1KΩ)	2.5mm ²
23	Auxiliary sensor 2	Resistive sensor (<1KΩ)	2.5mm ²
24	Relay output common point		2.5mm ²
25	D-Input 1	N.O. contact, 16A/30Vdc, defined (1)	2.5mm ²
26	D-Input 2	N.O. contact, 16A/30Vdc, defined (2)	2.5mm ²
27	D-Input 3	N.O. contact, 3A/30Vdc, defined (3)	1mm ²
28	D-Input 4	N.O. contact, 3A/30Vdc, defined (4)	1mm ²
29	D-Input 5	N.O. contact, 3A/30Vdc, defined (5)	1mm ²
30	D-Input 5		1mm ²
31	Charger excitation power output	If not used, do not connect to	1mm ²
32	D-Input 6	N.O. contact, 3A/30Vdc, defined (6)	1mm ²
33	D-Input 6		1mm ²
34	No		
35	No		
36	No		
37	No		
38	D-Input 7	Defined (7)	1mm ²
39	D-Input 6	Defined (6)	1mm ²
40	D-Input 5	Defined (5)	1mm ²
41	D-Input 4	Defined (4)	1mm ²
42	D-Input 3	Defined (3)	1mm ²
43	D-Input 2	Defined (2)	1mm ²
44	D-Input 1	Defined (1)	1mm ²
45	Magnetic pick-up signal {+}	1-70Vac	Two-core shielded cable
46	Magnetic pick-up signal {-}		
47	Battery supply (+B)	12V/24V (8-35Vdc continuous)	2.5mm ²

48	Battery supply (-B)		2.5mm ²
	H	ECU CAN communication port (Built-in termination resistor)	Two-core shielded cable
	L		
	S		
	A	RS485 communication port	Two-core shielded cable
	B		
	S		

**Note :**

- I Some port functions may not be available on all models, depending on whether the hardware is supported or not.
- I Port 5#、6#、7#、8# only GM6651 has.

2.3 Typical Wiring Diagram: GM6650

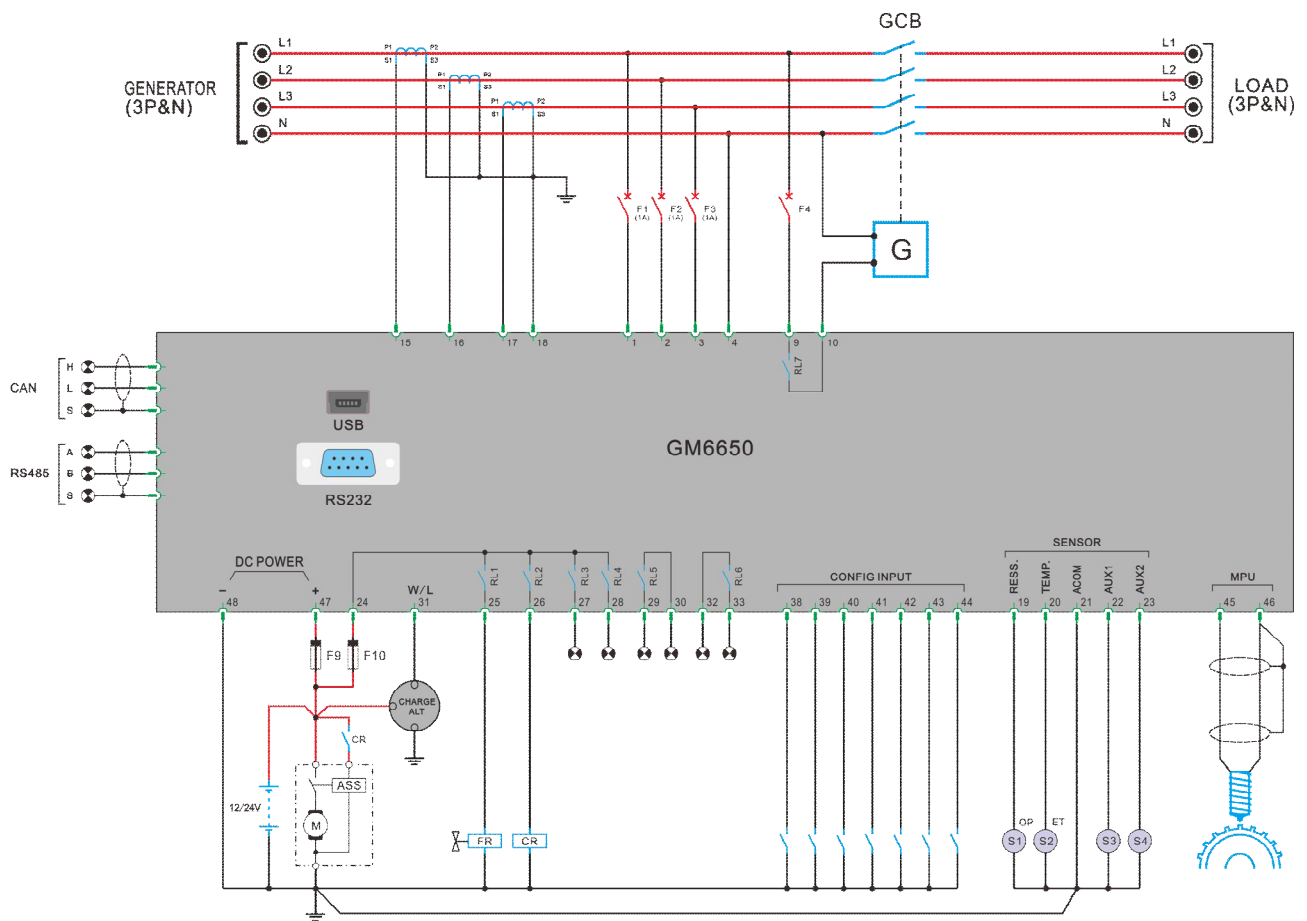

GM6651

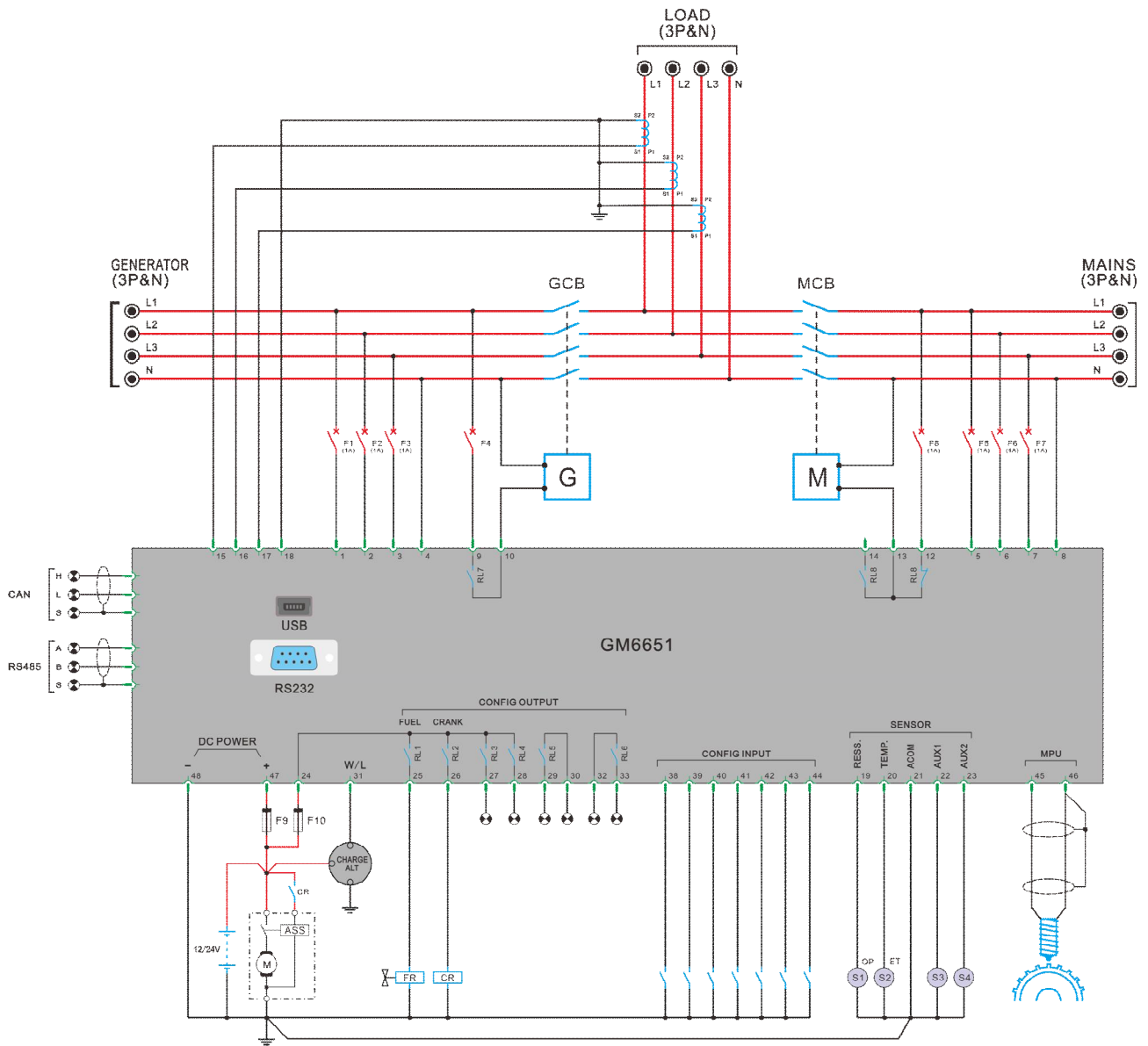







3 Panel Operation





The operation panel consists of 3 sections: LCD display indicating measurement parameters, LED indicator for common failure, and push buttons for Genset and selection of control modes.

LCD with 132×64pixels can display multi-line data in the same time. LCD also has a backlight so that the operator can clearly read information day or night. After pressing any button the backlight will automatically turn off after a preset time.

The LCD display and its control push buttons provide a friendly operational interface for the operator to easily control the Genset, read information and parameter setting.

Buttons and LEDs

Function Description	Tag
<p>Scroll Button Scroll menu for parameters display Enter into or exit parameters setting by pressing and holding this button for 2sec.</p>	
<p>Lamp Test/“+” Value Increase Pass and hold this button, all lights on the control panel are bright, used to test the indicator whether work. When in parameters setting mode, this button is used to increase value / scroll down menu.</p>	
<p>MUTE / “-” Value Decrease When failure occurs, alarm buzzer will sound. Pressing mute button will mute the sound. LCD will display mute icon. Press it again will clear the mute function, buzzer will continue to sound. When the mute function is effectively, LCD display mute symbols. When in parameters setting mode, this button is used to decrease value / scroll up menu.</p>	
<p>AUTO Mode Button This button controller operation mode, press this button repeatedly, can choose automatic mode and nonautomatic mode, when the LED indicator light on this button, the controller running in automatic mode. LCD display controller selected mode of operation.</p>	
<p>START Button/ RETURN The push button is used for manually start the Genset. When controller is running in MANUAL mode, press this button to start the generator. When in parameters setting mode, this button is used to return.</p>	
<p>STOP / RESET Button The Push button is used for manually stops the Genset. If failure occurs, press this button, the shutdown alarm lockout can be cleared. No matter what mode the controller is running, the "Stop" button is valid. In the "automatic" or other mode of operation, press and hold this button for 2sec to stop the generator, the controller automatically from other modes to manual mode. When executing the program in a shutdown of the generator set, press the button again, immediate shutdown and the cessation of associated control output.</p>	

<p>GEN. C/O Button In manual mode, this button is used to closing and opening of the power load switch. When a definable relay is set to "GEN closing / opening", this button is valid. LED will be lights in two cases: when there is no definable digital inputs are defined as "power closed auxiliary contacts", the "GEN closing / opening" action, the indicator light; when a definable digital input is defined as " power closed auxiliary contacts", the "GEN closing / opening" action and the switching value is effective, the indicator light, such as "GEN closing / opening" action, but "power closed auxiliary contacts" switching value is invalid, the indicator flashes.</p>	
<p>Mains C/O Button (Only GM6651 has) In manual mode, this button is used to closing and opening of Mains load switch. When a definable relay is set to " Mains closing / opening", this button is valid. LED will be lights in two cases: when there is no definable digital inputs are defined as " Mains closed auxiliary contacts", the " Mains closing / opening" action, the indicator light; when a definable digital input is defined as " Mains closed auxiliary contacts", the " Mains closing / opening" action and the switching value is effective, the indicator light, such as " Mains closing / opening" action, but " Mains closed auxiliary contacts" switching value is invalid, the indicator flashes.</p>	
<p>Shutdown Alarm (FAILURE) LED The LED will illuminate when pre-alarm occurs. The LED will illuminate permanently when shutdown alarm occurs.</p>	
<p>GEN. Normal LED Gen. normal LED will illuminate after both voltage and frequency of the Gen. reach loading voltage and frequency.</p>	
<p>MAINS Normal LED (only GM6651 has) Mains normal LED will illuminate after both voltage and frequency of the Mains reach the preset value range.</p>	

	<p>Warning: In installation and maintenance, can not be normal power generation lights and electricity normal light is illuminate to determine whether there is a dangerous voltage.</p>
---	--

4 Control and Operation Instruction

The controller has a variety of control mode, the operator panel can be set to automatic mode and the non-automatic mode. Non-automatic mode there are two kinds of situations, such as no definable switch is set to "activate the test mode", for the manual operation mode; if a definable switch is set to "Enable Test Mode" and effective, then is test operation mode.

4.1 Operation Mode Setting:

Description	Action
Press the "AUTO" button, the LED is illuminated, the controller is running in "AUTO" mode. Press the "AUTO mode" button again, the LED is off, the controller is running in non-automatic operation mode.	



NOTE:

Controller keeps the states for the previous mode when changing the operation mode, then implements the control procedure of the next mode according to the present states.



NOTE:

If a defined panel lock switch input will not change the operating mode of the controller.

4.2 AUTO Control Sequence

The controller is running in "AUTO" mode.

When Mains (Utility) is normal, Mains is on load: (only GM6651 has) :

When Mains is normal, both voltage and frequency of Mains are within the range of preset value, the Mains Normal LED illuminates, the timer for **Mains ON delay** is activated, when it times out, the MCB close/open relay closes, the transfer switch switches on Mains, the Mains Aux. Switch's contact closing, the MCB closed LED illuminates, Mains supply.



Warning:

- I The Mains Normal LED illuminated means that both voltage and frequency of Mains are within the range of preset values; Mains Normal LED flashing means either voltage or frequency of Mains are over the range of preset values; Mains Normal LED does not illuminate means that the Mains voltage is lower than 10% of the rated voltage.
- I Do not assume the Mains is not available if Mains Normal LED does not illuminate.

MCB failure: If MCB relay is closed output, the timer for Mains closing/opening is starting, when it times out, if the controller does not detect the mains side switch auxiliary contact closure, then Mains closing failure.



NOTE:

- I Above control procedure, assumes that one of configurable inputs has been configured as **Mains Aux. Switch Closed** and connects the switch's N.O. Aux. contact to this port.
- I If you do not configure an input as **Mains Aux. Switch Closed**, then the MCB LED illuminates is only an indication that the MCB relay should have been closed. Under this condition, the MCB failure function invalid, then the relative start function failure.
- I If you do not have a relay the mains closing / opening, then the controller with no power supply program, only the have electrical parameter detection and display, as mains status display and generator start request conditions.

Generator Auto Start Sequence:

Generator in the standby mode, only in the following situations occur, generator start-up program began:

- I Mains voltage failure, the controller detects the mains voltage or frequency exceeds the set level of extreme value, and delay the confirmation.

- I Mains failure occurs.

(The above two conditions only GM6651 has)

- I A defined as loading remote signal of definable input port is effective.

- I A defined as remote control of no-load start of definable input port is effective.

- I The built-in scheduler was activated, a start-up request

The Start delay timer is activated, when it times out, the preheat relay output is energised (if preheat function selected), the timer starts. When it times out, the fuel relay output is energised, and operates the fuel solenoid of the engine. After 300ms delay, the start relay closed output, the start

motor engages and begins to crank. When the engine speed reaches the crank cutout RPM, the start output is de-energised and the safety-on delay starts. When the safety-on times out, if the controller detects that the parameters of the Genset such as voltage, frequency, oil pressure, coolant temperature are normal, and no other failure is detected this indicates the Genset has successfully started and running normally. The LCD displays the Genset Measurement Parameters.

If you have selected idle function, the idle relay will be closed at the same time as the crank relay is closed, the idle timer will begin counting down after successful crank, when it times out, the idle relay opens, other procedure is the same as above.

**NOTE:**

- | When the engine is running at idle period, the controller does not detect the failure of low-voltage, low-frequency, low-speed and charging failure.
- | When no one input port as defined as remote start, the "remote start" signal is not as boot judgment condition.

**NOTE:**

The start motor will power off while cranking if there are one of the following conditions occur:

- | The generator's frequency reaches the preset value (configurable cranking cutout value);
- | The AC engine speed reaches crank cutout value;
- | Generator's voltage reaches the crank cutout value (optional);
- | Charger voltage reaches crank cutout value (optional);
- | Cutout P-delay time's up (optional);
- | Cranking time's up.

The controller can not implement crank procedure in one of the following conditions:

- | The generator's frequency reaches the preset value (configurable cranking cutout value);
- | The AC engine speed reaches crank cutout value;
- | Generator's voltage reaches the crank cutout value (optional);
- | Oil pressure switch is opened or oil pressure is higher than crank cutout value (optional).

**Warning:**

- | If the control system does not use the speed sensor, that is, the engine cut off the signal from the generator frequency, must ensure that the generator in the process of turning, the output voltage is greater than the controller measure the voltage to avoid damage to the motor.

Repeat Crank: During the crank period, if the engine can not ignite and controller will not output start signal during crank rest. Once crank rest timer times out the start relay energises once again and will attempt to start engine again. The above procedure will be repeated until engine successfully ignites or reaches the preset number of crank attempt.

If any shutdown alarm occurs during crank, controller will stop cranking immediately, and the Genset only can be restarted after clearing the failure and reset.

Start Failure: When the procedure above repeats again and again and reaches the preset number of crank attempt, the crank relay output is then de-energised. The failure LED illuminates and the LCD displays fail to start.

**Warning:**

- I If fail to start occurs, operator must check the whole Genset system to find out failure reason, only after clearing the failure can press “reset button to relieve fault lock out status, and restart the genet

Power supply process:

When the generator running, the generator voltage and frequency reaches to the the generation load voltage and power generation with load frequency, power generation normal light, power generation delay timer is started, time's up, the GCB relay closure outputs, the transfer switch power generation side switch is closed, the power generation side switch auxiliary contacts are closed, the GCB indicator illuminated , power supply

**NOTE:**

- I No-load remote signal input port is valid, or the scheduling mode is set to no load, the generator only no load operation, not closing.
- I The power generation closing command must be issued after the safety monitoring delay time has elapsed .
- I If there is not a D-input port is defined as power generation closed auxiliary contact, this time, the power generation closing indicator light only shows the controller of the power closing relay closed output.

Mains return and generator shutdown sequence: (only GM6651 has) :

When Mains resumes to normal, the mains voltage and frequency in setting rang, mains normal LED illuminates, the **Mains ON delay** timer is activated, GCB relay is de-energised after it times out, MCB relay closing output, transfer switch mains side closed, the Mains Aux. Switch's contact closed, MCB closed LED illuminates. Mains supply.

Such as when the occurrence of mains closing failure, power generation closing relay immediately closed output, power supply. Only after the fault is cleared, fault reset, can restore the electricity supply.

Generator unloading and shutdown process

Under the following conditions, the controller sends the generator uninstal command:

- I When mains voltage has returned, the mains power supply delay timer is activated,then the times out. (**only GM6651 has**) .
- I Loading remote signal of definable input port is invalid.
- I The scheduling boot request is invalid.

In GOB, the mains power supply is normal, cooling delay began to countdown , when it times out, the controller fuel relay action, immediately disconnect the fuel solenoid ,into standby generator.

Stop Failure: When cool down times out, the fuel relay action and the timer for stop delay begins. If the controller detects that the voltage of the generator is greater than the cutout values, or the speed is greater than the RPM, or the oil pressure switch is off, or the oil pressure is greater than the crank cutout oil pressure, the failure LED illuminates and the LCD displays **Fail to stop**.

**NOTE:**

- I After stop failure occurs and the generator can not be started unless it is removed and reset.

4.3 MAN control Sequence

The controller is running in “MANUAL” mode.

Mains is normal, Mains supply (only GM6651 has) :

When Mains is normal means that both voltage and frequency of Mains are within the range of preset value, the Mains Normal LED illuminates, the MCB relay will not close automatically.

Press the Mains closing/opening” button, manually closing the mains switch MCB, the mains side of the auxiliary switch contacts closed, MCB LED illuminates, mains supply. Press the Mains closing/opening” button again, manual opening of the mains switch MCB, the mains side switch auxiliary contact is disconnected, the MCB LED is turned off.

If you press the “Mains closing/opening” button, generation side switch GCB closing power supply, the GCB relay will be opened first, then switch switch generation side switch GCB is disconnected, the MCB relay closes output, Mains supply.



NOTE:

- I When the controller is running in “MANUAL” mode, you need manually closing, mains supply, mains must be normal, otherwise the “C/O” button will be invalid.

Generator starting sequence:

Pressing “START” button the fuel relay action, and open the fuel solenoid of engine. After 300ms delay, the start relay closed output, the start motor engages and begins to crank, When the engine speed reaches the crank cutout RPM, the controller output is de-energised and the safety-on delay starts. When the safety-on times out, if the controller detects that the parameters of the genset such as voltage, frequency, oil pressure, coolant temperature are normal, and no other failure is detected this indicates the Genset has successfully started and running normally. The LCD displays the Genset Measurement Parameters.

After both voltage and frequency of generator respectively reached the loading value, the Gen. Normal LED illuminates, the GCB relay will not be closed automatically.

Press the “power closing/opening” button, manually close the power generation side switch GCB, power supply, power generation side switch auxiliary contact closed, GCB closed LED illuminates. Press the “power closing/opening” button again, manually open the power side switch GCB, power generation side switch auxiliary contact is disconnected, the GCB closed LED is turned off .

If you press the “power closing/opening” button, the mains side switch MCB closing power supply, the mains closing relay first disconnected, the switch switch on the side of the electricity switch MCB; power closing relay and then closed output.



NOTE:

- I When the controller is running in “MANUAL” mode, you need manually closing, power supply, power must be normal, otherwise the “C/O” button will be invalid.
- I Power and mains in any case, the electrical linkage, that is, the MCB relay and the GCB relay will not close output at the same time.

Generator opening and stopping sequence:

Press "STOP" button, GCB relay opens, the generator is unload, the cool down timer starts, when it times out , the fuel relay action, disconnect the fuel solenoid immediately, generator stops and goes to standby status.

If press "STOP" button again during cool down period, generator stops immediately without cool down time..

Mains and power fast conversion (only GM6651 has) :

A special occasion, the mains in the normal supply, when the mains fails, you need to generate immediately supply, in order to shorten the disconnect time of load as far as possible. To meet this requirement, the controller provides relevant parameter settings and features, as follows:

Relevant parameter settings:

No.	Parameter	Preset	Description
7.10	M alarm delay	0s	According to actual needs, you can set the value to 0
7.11	M on delay	0s	According to actual needs, you can set the value to 0
7.16	Prohibit return	1	According to actual needs to set the value.
7.17	M fail G to load	1 (Auto)	
2.19	G on delay	0s	According to actual needs, you can set the value to 0

Operation:

In automatic mode or manual mode, the mains is normal, MCB supply.

If in automatic mode, the operation mode of the controller is selected for the manual mode. Press "Open" key, generator up and running, if no other operations, the generator will keep no-load running, unless of downtime.

If Mains failure, the controller immediately disconnect MCB relay output, the power relay closure outputs, power supply. The entire process due to the generator start all relevant times, and transformation of time as short as possible, the load of the power-off time can be as short as possible.

In the process of normal power generation, mains return to normal, there are two control process:

First process: The value of **Prohibit return** is set to "0", after the mains is normal, disconnect the GCB relay output, mains relay closure output, mains supply. Generators continue to keep no-load running, unless of downtime or press the "stop" button.

Second process: The value of **Prohibit return** is set to "1", after the mains is normal, the controller no reaction, continue to keep the power supply, unless the downtime.

After the mains return to normal, if downtime, whether the **Prohibit return** how to set up, the mains power is restored.

**Note:**

I In practical applications, the load power changeover switch related to the intrinsic conversion time.

4.4 TEST Controll Sequence

Test mode in a configurable switching is set to "Enable Test Mode" and effectively, the controller is in test operation mode.

GM6651 is running in "TEST" mode, it equivalent to the Mains failure in automatic mode, the operation of the controller program is equivalent to the operating procedures in automatic mode.

GM6650 is running in "TEST" mode, there are two cases, when the parameters of the **test mode** is set to "no-load" , it equivalent to a defined configurable port for **the remote no-load boot** is valid; When the parameter of the test mode is set to "load", it equivalent to a defined onfigurable port for **the remote load boot** is valid.

When the test mode is active, the start-up delay timer starts. When it times out, If it has preheat function, preheat relay closure outputs, warm-up timer is started. When it times out, the throttle relay action, engine fuel solenoid valve opens ,After 300 ms the starter relay closure outputs, engine cranking motor power, start turning, cutting speed, turning when the engine is running speed reaches the controller stop start output delay timer starts timing of the safety supervision, to counting time, if the controller detects that the voltage, frequency, oil pressure, water temperature, and other parameters of the generator set is normal, there is no other fault, it means the generator sets start successful, normal operation, the LCD display measurement parameters.

Load test:

When the generator is running, the power supply delay timer is activated, then the timer times out:

GM6650 Controller GCB relay closure outputs, the generation load switch GCB closed, power generation side switch auxiliary contacts are closed, GCB indicator illuminates, power supply.

GM86651 controller MCB relay closure action, GCB relay closure outputs, the transfer switch power generation side switch GCB closed, power generation side switch auxiliary contacts are closed, the generator indicator illuminates, power supply. If mains voltage is normal, mains voltage normal indicator illuminates.

The controllers keep power supply, until the following actions occur::

- I Press "STOP" button, generator stop
- I Switching mode to the "automatic": controller keep all control of the state of the test mode, and then according to the prevailing conditions, run the control program of the automatic mode.

4.5 Start and stop sequence of engine whose fuel solenoid is N.O.type:

There are two kinds of fuel solenoids for an engine, one is N.C. type, the valve of this solenoid is closed when the engine is in standby and it can be opened by switching on power; another is N.O. type, the valve of this solenoid is opened when engine is in standby and it can be closed by switching on power. All control sequences above are for N.C. type.

Start control sequence for N.O. type:

During the starting sequence the fuel relay of controller will not energise, fuel solenoid is no power, fuel solenoid open by the fuel solenoid to no-activate.

Stop control sequence for N.O. type:

During the stop sequence, the fuel relay energises, fuel solenoid is on power, the fuel solenoid action, the solenoid closed and the engine begins to stop. After a delay (same as Stop delay) fuel relay disconnect, disconnecting the supply from the fuel solenoid.

Other control sequences are same as engine whose fuel solenoid is N. C. type.

4.6 Idle function:

For **idle** function set one of the configurable outputs as **idle**.

Refer to the flow chart for start and stop for idle control flows.



NOTE:

- I Controller will not detect under voltage, under frequency, under speed, and charge failure during idle period.

4.7 Preheat function:

For preheat function, one of the configurable outputs as **Preheat**, the controller has 7 type selectable preheat control modes as below:

Mode 1 — during preheat time, preheat relay closure output.

Mode 2 — during preheat time, preheat relay closure output until the successful ignition.

Mode 3 — during preheat time, preheat relay closure output until safety-on delay times out.

Mode 4 — one of the configurable inputs is defined as **Preheat**, preheat relay closure output when this configurable input is active, and disconnect when configurable input is inactive.

Mode 5 — the temperature measurement value from the T-sensor port is used as the preheat control signal. When the temperature measured by the controller is lower than the preheated Preheat ON value, the preheat relay closes the output until the temperature reaches the Preheat OFF value, the preheat relay is disconnected.

Mode 6 — the temperature measurement value from the A-sensor 1 port is used as the preheat control signal. When the temperature measured by the controller is lower than the preheated Preheat ON 1 value, the preheat relay closes the output until the temperature reaches the Preheat OFF 1 value, the preheat relay is disconnected.

Mode 7 — the temperature measurement value from the A-sensor 2 port is used as the preheat control signal. When the temperature measured by the controller is lower than the preheated Preheat ON 2 value, the preheat relay closes the output until the temperature reaches the Preheat OFF 2 value, the preheat relay is disconnected.

For preheat mode 1 to 3, please refer to the flow chart for start and stop for **Preheat** control flows.

For preheat mode 4 to 7, preheat function is active immediately when the controller is switched on power.

During crank period, the preheat relay output will not energise in any of above modes.

4.8 The function of forcing start:

Reason to add this function to the controller is that when the engine under abnormal conditions, e.g. the battery voltage is too low or ambient temperature is too low, or generator only outputs voltage at a high speed when magnetic pick-up is not used, the Genset cannot be started successfully when it implements the build-up cranking process of controller. There are 2 methods to solve these conditions in the controller:

Method 1: In manual mode, press the "Start" button, the controller crank relay closes output, the maximum closing time does not exceed the preset crank time. To extend the crank time, press the "Start" button continuously without changing the relevant parameters, depending on the duration of the hold button. After successfully crank, the safety monitoring delay time starts, and the procedure and protection is followed.

Method 2: In manual mode, set the parameter "EX. Crank permit" to "1" and add a switch PB to the control circuit as shown below. When the speed is up to 150RPM, the engine crank, if the speed sensor is not used, the generator voltage $\geq 20VAC$, the controller function is triggered, the throttle relay output, when the speed reaches the crank cutout RPM, the safety monitoring delay timer Start, after the procedures and protection is normal. If in the safety monitoring time, the engine speed is lower than 150RPM, the controller reset, re-enter the standby state

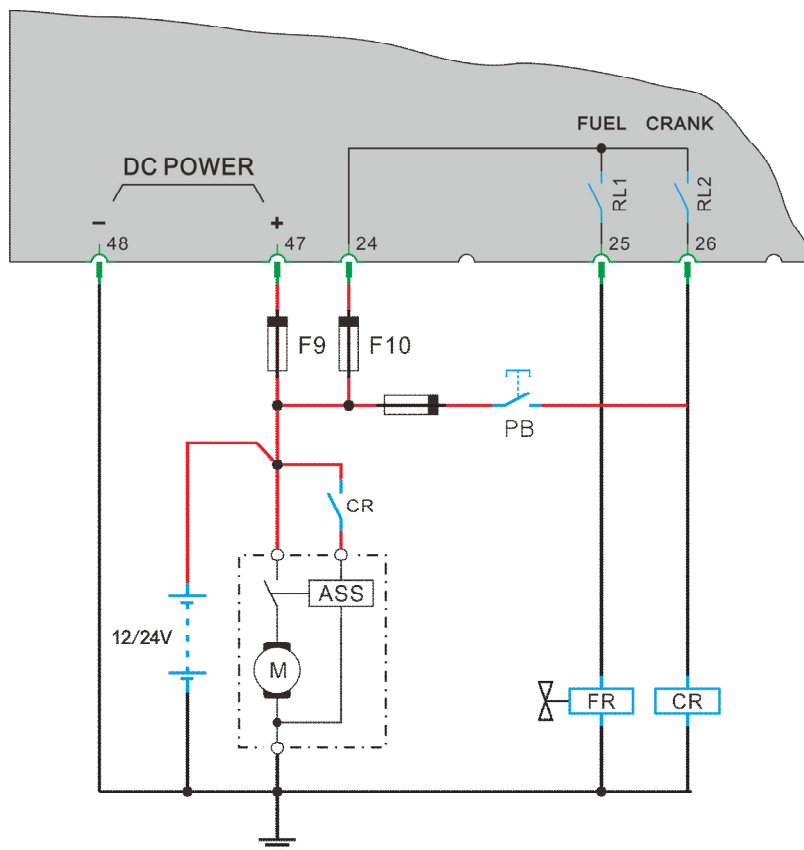

Warning:

- | We normally don't recommend using the method 2;
- | In practical applications, pay attention to the installation of the PB switch, prohibit the running of the unit to crank.

4.9 Dual mutual standby:

Under normal, the user according to their actual needs or successively or simultaneously purchase two independent operation of the generator unit.

Dual mutual standby for the use of GM * controller generator set, through a simple control of the line connection and parameter settings, can be composed of mutual standby dual generator power supply system provides a possible.

Typical application circuit 1:

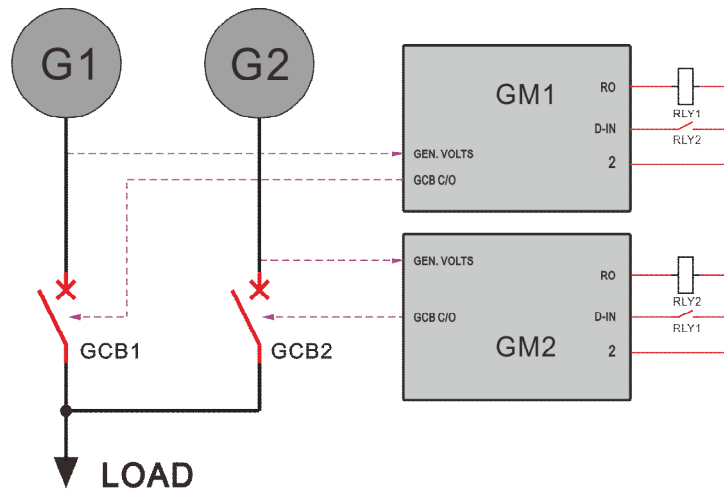

Function Description:

I A D-input of the two controllers is defined as "dual mutual standby input", a relay output is defined as "dual mutual standby output," the external circuit connected as above.

I Through the parameter "dual mutual standby" is set to the main unit or standby unit, two units can only one for the main unit, the other for the standby unit.

I Main unit is defined as a load remote start signal discrete input valid, or mains failure, or scheduling function effectively, start running and switch on the power supply. Standby unit at standby until the timing of the spare time to each other, the end, or the main controller shutdown fault, main unit uninstall downtime, output action of the controller's dual machine spare stop each other, alternate controller dual standby for each other The input signal is invalid, and then issued a command, the standby unit start running and switch on the power supply, its dual machine mutually alternate output action. When the end of the standby controller internal a mutual backup time timing master controller dual each other alternate input signal is invalid, and issued the command, the master unit start running and switch on the power supply, dual standby output output each other action , standby unit uninstall downtime. As long as the the master controller boot conditions have been met, the two machine running load and standby will repete.



Warning:

- I In above applications, the controller provides electrical interlock, so that the two generators will not run the power supply at the same time.
- I In any case, the power switch must have a mechanical interlock.

Typical application circuit 2:

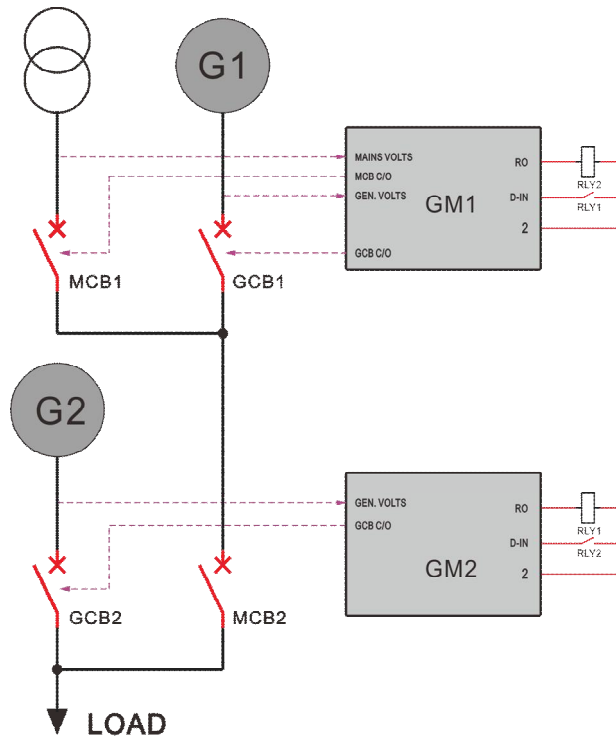

Function Description:

I A D-input of the two controllers is defined as "dual mutual standby input", a relay output is defined as "dual mutual standby output," the external circuit connected as above.

I Through the parameter "dual mutual standby" is set to the main unit or standby unit, two units can only one for the main unit, the other for the standby unit.

I When mains failure, or scheduling function effectively, the primary unit start running and switch on the power supply. Standby unit at standby until the timing of the spare time to each other, the end, or the main controller shutdown fault, main unit uninstall downtime, output action of the controller's dual machine spare stop each other, alternate controller dual standby for each other The input signal is invalid, and then issued a command, the standby unit start running and switch on the power supply, its dual machine mutually alternate output action. When the end of the standby controller internal a mutual backup time timing master controller dual each other alternate input signal is invalid, and issued the command, the master unit start running and switch on the power supply, dual standby output output each other action , standby unit uninstall downtime. As long as the the master controller boot conditions have been met, the two-machine running load and standby will repete.

I The switch MCB2 on circuit drawings is closed when either of GCB1 or MCB1 is closed, and the application circuit is designed by the user according to the actual design.



NOTE:

I When the " dual mutual standby" parameter is set to the standby, its internal scheduling function is invalid

5 Measure and display data

Mains V_{Ph-N} L1-N L2-N L3-N

Mains V_{Ph-Ph} L1-L2 L2-L3 L3-L1

Mains frequency Hz (L1)

(The above data only GM6651 has)

Gen V_{Ph-N} L1-N L2-N L3-N

Gen V_{Ph-Ph} L1- L2 L2- L3 L3- L1

Gen frequency Hz (L1)

Gen / Mains 3 phases current I1 I2 I3

Gen / Mains 3 phases apparent power AL1 AL2 AL3 ΣA

Gen / Mains 3 phases active power PL1 PL2 PL3 ΣP

Gen / Mains 3 phases reactive power QL1 QL2 QL3 ΣQ

Gen / Mains 3 phases power factor PFL1 PFL2 PFL3 PF(AV)

(The above data only GM6651 has)

Engine speed RPM (signal is from the generator speed sensor, the power voltage HZ or ECU)

Engine oil pressure Bar/PSI (signal is from engine LOP sensor or ECU)

Engine coolant temperature $^{\circ}C/^{\circ}F$ (signal is from engine Temp. sensor or ECU)

Auxiliary sensor 1

Auxiliary sensor 2

Battery voltageVdc

Genset running time Hour

6 Pre-alarm and Shutdown Alarm

Controller to configure different levels of alarm, according to actual application requirements for each limit beyond the protection function is triggered and control procedures to be configured, different grade configuration table is as follows:

Alarm level	Screen display	"Warning" LED flash Sound sirens	Power load switch GCB disconnect	"Fault" LED illuminate Close generators
A1 Silence Warning	Y	N	N	N
	Warning: This warning is not to interrupt the operation of equipment, do not issue public alarm, the screen displays a warning content, except relay action is defined as trigger a warning, without any other control behavior. Related events recorded in the event log.			
A2 Voice and light Warning	Y	Y	N	N
	Warning: This warning is not to interrupt the operation of equipment, Public Warning "LED lights lit and sound the alarm, the screen displays a warning content, except is defined trigger a warning relay action, without any other control behavior. Related events recorded in the event log.			
A3 Unload Warning	Y	Y	Soft Uninstall	N
	Warning: Public "Warning" LED illuminate and sound the alarm, the controller performs the uninstall program, the screen displays a warning content and trigger a defined warning relay action generator without stopping the machine. Related events recorded in the event log.			
B1 Unload Shutdo wn	Y	Y	Soft Uninstall	Cooling timing
	Shutdown failure: public "fault" LED illuminate and sound the alarm rang, the controller performs the uninstall program, opening, the generator cooling down, the screen displays the content of the fault and the program process information. Related events recorded in the event log. Troubleshooting, fault reset, and can be re-operations unit.			
B2 Cooling Shutdo wn	Y	Y	Immediately	Cooling timing
	Shutdown failure: public "fault" LED illuminate and sound the alarm, real-time sub-gate generator cooling down, the screen displays the fault content and program process information. Related events recorded in the event log. Troubleshooting, fault reset, and can be re-operations unit.			
B3 Immedia tely Shutdo wn	Y	Y	Immediately	Immediately
	Shutdown failure: public "fault" LED illuminate and sound the alarm, real-time sub-gate, immediate shutdown generator, the screen displays the fault content. Related events recorded in the event log. Troubleshooting, fault reset, and can be re-operations unit.			
Control	N	N	N	N
	Control: only as a control condition to trigger related control command.			

NOTE:



- I Warning is a non-serious fault state, temporarily do not constitute a hazard to the generator system, but to remind the operator not to meet the requirements of the situation and timely solution to ensure continuous operation of the system. When the warning occurs, the warning indicator immediately, the fault is not locked, the unit does not stop, once the failure to remove the warning automatic release.
- I Genset shutdown after the shutdown failure, fault status locked when the fault is cleared, and then press the reset button, fault lock before lifting.

7 Parameters Setting

7.1 SYSTEM

NO.	Items	Setting Range	Preset
1.0	Quit		
1.1	Language		
1.2	Password	0000 to 9999	
1.3	Pressure unit	0Bar/1PSI	0
1.4	Temperature unit	0°C/1°F	0
1.5	Comm. address	1 to 247	1
1.6	Startup mode	0 Man/1 Auto/ 2 Last	0
1.7	CT ratio	5:5 to 30000:5	1000:5
1.8	PT ratio	1.0:1 to 100.0:1	1.0:1
1.9	Rated voltage	45 to 30000VAC	220
1.10	Rated current	1 to 30000A	1000
1.11	Rated active power	1 to 16000KW	500
1.12	Voltage type	1 to 5 / Not used	1
1.13	Display contrast	1 to 9%	5
1.14	Auto scroll time	1 to 60 s / Not used	Not used
1.15	Starting alarm	0 N/1 Y	0
1.16	Mutual standby	0 Not used /1 Host /2 Slave	0
1.17	Mutual-S time	1 to 9999 min / Not used	Not used
1.18	CB close pulse	1 to 60s/0 Continuous	Continuous
1.19	Reset to MAN	0 N/1 Y	0
1.20	Default settings		
1.21	Firmware Update		

Menu descriptions:

Language

I Used to select the Language which is displayed on the LCD.

Password

- I There are 3 levels of password (CL0/CL1/CL2) for different users.
- I CL0 for the operator, who can read parameters, start and stop controller. The default setting is no password.
- I CL1 for the technician, who has the authority of CL0 and can modify all parameters, the default setting is "1111".
- I CL2 for factory, who have the authority of CL1 and Firmware update, the default setting as "2222".
- I All passwords are automatically inactive 60 seconds after exiting menu.

Pressure unit

- I Used to define oil pressure unit which is displayed on the LCD. "0" stand for Bar, "1" stand for PSI.
- I Transfer formula: $P[\text{psi}] = P[\text{bar}] * 14.503$.

Temperature unit

- I Used to define temperature unit which is displayed on the LCD. "0" stand for °C, "1" stand for °F.
- I Transfer formula: $T[°F] = (T[°C] * 1.8) + 32$.

Comm. address

- | Used to configure ID address for MODBUS.
- | Each controller on the same MODBUS has a unique communication address.

Startup mode

- | Used to configure the Startup mode of controller when it is powered up.
- | When parameter is configured as "0", the controller will be in Manual mode when it is powered up.
- | When parameter is configured as "1", the controller will be in Automatic mode when it is powered up.
- | When parameter is configured as "2", the controller will be in the mode which is the same as last time when it is powered up.

CT Ratio

- | Define the primary and secondary ratio of the generator or load CT, the secondary current is fixed at 5A.
- | Used to calculate for power or load: A, KVA, KW, KVA_r, PF, KWh, KVA_rh.
- | Used to set the limit trigger: overcurrent, overload , etc.

PT Ratio

- | Definition Gen and Mains Voltage PT ratio of the primary and secondary.
- | Used to calculate for power or Mains: V, HZ, KVA, KW, KVA_r, PF, KWh, KVA_rh.
- | Used to set the limit trigger:: high / low voltage, etc.

Rated voltage

- | Used to define the power and mains rated voltage.
- | As a reference value for high / low voltage.

Rated current

- | Used to define the generator and mains rated current.
- | As a reference value for overcurrent limit.

Rated active power

- | Used to define the generator rated active power.
- | As a reference value for active power.

Voltage type

I There are 5 voltage types: “Y” 3P4W, “ Δ ” 3P4W, 3P3W, 2P3W, 1P2W。

I “Y” 3P4W (Star three-phase four-wire)

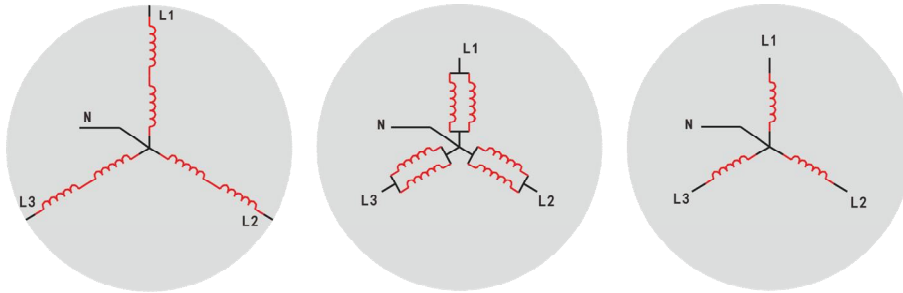

I “ Δ ” 3P4W (Angle three-phase four-wire)

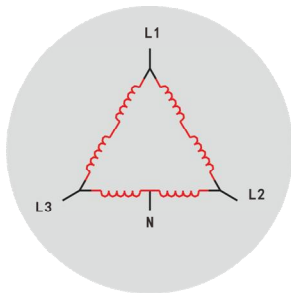

I 3P3W (Three-phase three-wire)

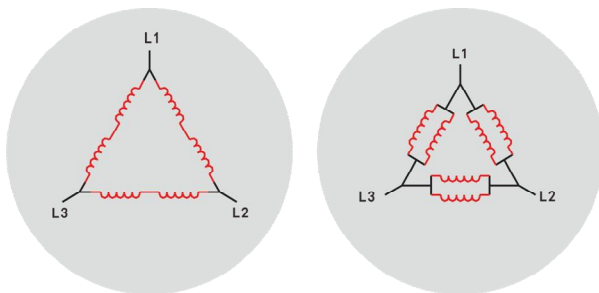

I 2P3W (Two-phase three-wire)

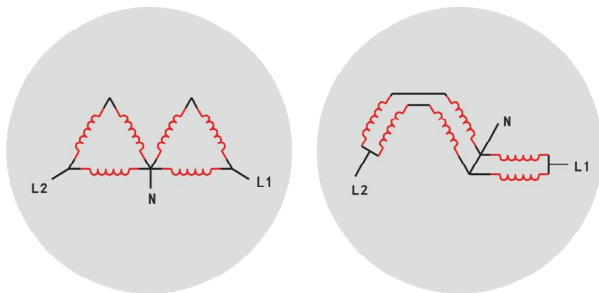

I 1P2W (single phase two-wire)

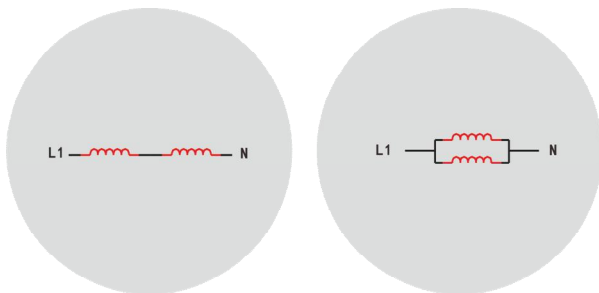

I When the parameter is set to " not use", the controller does not measure, not show the generation of electrical data.

Display contrast

- I Used to adjust the controller LCD display contrast.

Auto scroll time

- I Use to setting the interval of LCD screen display scroll page, any button will start auto scroll page after 30 seconds.
- I When the parameter is set to " not use" , press "▶" manually scroll.

Starting alarm

- I When the parameter is set to "0", the controller will not audible alarm before the generator set start.
- I When the parameter is set to "1" in the automatic operation mode, to start the generator set during the start-up delay and the warm-up, an audible alarm.

Mutual standby

- I When the parameter is set to "0", the controller to run as an independent unit.
- I When the power supply system have two generating units, and requires two units each other standby power for the same load, the two controllers parameters, one set to "host", and another is set to "slave". Generator sets priority is set to "host" to run the power supply, generator set is set to "slave" as a stanby machine.
- I The details please refer to the description of the dual mutual stanby function.

Mutual-S time

- I When the controller starts dual mutual stanby function, this parameter is used to adjust the two generating units continued running time.
- I The details please refer to the description of the dual mutual stanby function.

CB close pulse

- I When the parameter is set to "continuous", the closing relay of the controller will continuously output ,unless controller failure or tripping command.
- I When the parameter is set to "value", after the controller sends a close command , closing relay closure outputs, the timer starts, when the accumulated reaches to set the pulse time, closing relay disconnect.

Reset to MAN

- I When the parameter is set to "1", the controller shutdown fault, fault condition lock. When the fault is cleared, press the reset button on the panel, however the controller before in any control mode are automatically switched to manual operation mode.
- I When the parameter is set to "0", the controller shutdown fault, fault condition lock. When the fault is cleared, press the reset button on the panel, the controller keep before control mode.

**Warning:**

When the "reset to manual mode" parameter is set to "0" before is in automatic operation mode, press the fault reset key, in the case of other generators open condition is satisfied, generator sets may be startered in no warning.

Default settings

- I Parameters returned to the factory default.
- I Use CL1 level password to restore the general alarm limit and other parameters for the factory value.
- I Use CL2 level password to restore all parameters to factory values.

Firmware Update

- I Used for the controller is set to online programming mode, after enter the 30 seconds will automatically exit if the upgrade not proceed.
- I Must enter CL2 (Factory) permission password is "2222".
- I Before electrify, press and hold the lamp button can quickly enter the mode.
- I After the upgrade you need to restart the controller.

7.2 GENERATOR

NO.	Parameter	Setting range	Preset
2.0	Quit		
2.1	GEN V-monitor type	0 ph-ph/1 ph-n	1
2.2	GEN-V under 1		
	Function	0 N/1 Y	1
	Limit	20 to 200%	90%
	Delay	0 to 999s	5s
	Delay by	0 to 3	3
	ALM. class	0 to 6	2
2.3	GEN-V under 2		
	Function	0 N/1 Y	0
	Limit	20 to 200%	85%
	Delay	0 to 999s	5s
	Delay by	0 to 3	3
	ALM. class	0 to 6	3
2.4	GEN-V over 1		
	Function	0 N/1 Y	1
	Limit	20 to 200%	115%
	Delay	0 to 999s	5s
	Delay by	0 to 3	3
	ALM. class	0 to 6	2
2.5	GEN-V over 2		
	Function	0 N/1 Y	1
	Limit	20 to 200%	120%
	Delay	0 to 999s	5s
	Delay by	0 to 3	3
	ALM. class	0 to 6	3
2.6	GEN-Hz under 1		
	Function	0 N/1 Y	1
	Limit	10.0 to 100.0Hz	48.0Hz
	Delay	0 to 999s	5s
	Delay by	0 to 3	3
	ALM. class	0 to 6	2
2.7	GEN-Hz under 2		
	Function	0 N/1 Y	0
	Limit	10.0 to 100.0Hz	45.0Hz
	Delay	0 to 999s	5 秒
	Delay by	0 to 3	3
	ALM. class	0 to 6	3
2.8	GEN-Hz over 1		
	Function	0 N/1 Y	1
	Limit	10.0 to 100.0Hz	55.0Hz
	Delay	0 to 999s	5s
	Delay by	0 to 3	3
	ALM. class	0 to 6	2

2.9	GEN-Hz over 2		
	Function	0 N/1 Y	1
	Limit	10.0 to 100.0Hz	57.0Hz
	Delay	0 to 999s	5s
	Delay by	0 to 3	3
	ALM. class	0 to 6	3
2.10	GEN-I over 1		
	Function	0 N/1 Y	1
	Limit	50 to 300%	110%
	Delay	0 to 999s	5s
	Delay by	0 to 3	3
	ALM. class	0 to 6	2
2.11	GEN-I over 2		
	Function	0 N/1 Y	1
	Limit	50 to 300%	115%
	Delay	0 to 999s	5s
	Delay by	0 to 3	3
	ALM. class	0 to 6	3
2.12	GEN-KW over 1		
	Function	0 N/1 Y	1
	Limit	20 to 200%	110%
	Delay	0 to 999s	5s
	Delay by	0 to 3	3
	ALM. class	0 to 6	2
2.13	GEN-KW over 2		
	Function	0 N/1 Y	1
	Limit	20 to 200%	120%
	Delay	0 to 999s	5s
	Delay by	0 to 3	3
	ALM. class	0 to 6	3
2.14	Phase rotation		
	Function	0 N/1 Y	1
	Phase rotation	CW(+)/CCW(-)	CW
	Delay	0 to 999s	5s
	Delay by	0 to 3	3
	ALM. class	0 to 6	3
2.15	GCB close		
	Function	0 N/1 Y	0
	Delay	0 to 999s	5s
	ALM. class	0 to 6	2
2.16	GCB open		
	Function	0 N/1 Y	0
	Delay	0 to 999s	5 秒
	ALM. class	0 to 6	2
2.17	GEN. loading Volt	20 to 200%	90%
2.18	GEN. loading Hz	10.0 to 100.0Hz	48.0Hz
2.19	GEN. on delay	0 to 9999s	5s
2.20	Test mode	0 unload /1 Load	0
2.21	Soft unload time	1 to 9999s	1s

Menu descriptions:**GEN V-monitor type**

- I Use to select a controller in **ph - ph** voltage or **ph - n** voltage as monitoring object..
- I In different voltage input type, select "**ph - ph**" or "**ph - n**", monitoring voltage is different, specifically in the following table:

Parameter Voltage type	Ph - ph	Ph - N
"Y" 3P4W	V_{L1-L2} , V_{L2-L3} , V_{L3-L1}	V_{L1-N} , V_{L2-N} , V_{L3-N}
"△" 3P4W	V_{L1-L2} , V_{L2-L3} , V_{L3-L1}	V_{L1-N} , V_{L2-N} , V_{L3-N}
3P3W	V_{L1-L2} , V_{L2-L3} , V_{L3-L1}	
2P3W	V_{L1-L2}	V_{L1-N} , V_{L2-N}
1P2W		V_{L1-N}

GEN-V under 1&2

- I Controller provides two levels of low-voltage limit monitoring for users to choose for warning, fault shutdown and control. If you select 1/2/3 alarm level, when the protection function triggered, LCD screen displays "! W: GEN-V under 1" or "! W: GEN-V under 2"; if select 4/5/6 alarm level, when protection function triggered, LCD screen displays "! A: GEN-V under 1" or "! A: GEN-V under 2"

Function	Select "Y", the monitoring function is active; Select "N", the monitoring function is invalid.
Limit	Used to define low-voltage protection threshold. When the generated voltage reaches or falls below this threshold, lasts time longer than the delay time, the define operation of alarm levels are triggered.
Delay	If the generation low voltage exceeds the value of the delay time set, the define operation of alarm levels are triggered; if low voltage higher than the voltage limit in the delay before termination, the delay time is set to zero.
Start point	Defined time range of effective monitoring function: Set (0) : always effective; Set (1) : starting from crank, monitoring effectively at the same time; Set (2) : from safety supervision delay time over, start effective; Set (3) : after running ,start effectively.
Alarm levels	Used to define the protection is triggered, and what is the controller will do. Details refer to the alarm level configuration table.

GEN-V over 1&2

- I Controller provides two levels of high-voltage limit monitoring for users to choose for warning, fault shutdown and control. If you select 1/2/3 alarm level when the protection function triggered, LCD screen displays "! W: GEN-V over 1" or "! W: GEN-V over 2"; if select 4/5/6/ alarm level when protection function triggered, LCD screen display "! A: GEN-V over 1 " or " ! A: GEN-V over 2".

Function	Select "Y", the monitoring function is active; Select "N", the monitoring function is invalid.
Limit	Used to define high voltage protection threshold. When the generated voltage reaches or falls below this threshold, lasts time longer than the delay time, the define operation of alarm levels are triggered.
Delay	If the generation high voltage exceeds the value of the delay time set, the define operation of alarm levels are triggered; if high voltage higher than the voltage limit in the delay before termination, the delay time is set to zero.
Start point	Defined time range of effective monitoring function: Set (0) : always effective;; Set (1) : starting from crank, monitoring effectively at the same time; Set (2) : from safety supervision delay time over, start effective; Set (3) : after running ,start effectively.
Alarm levels	Used to define the protection is triggered, and what is the controller will do. Details refer to the alarm level configuration table.

GEN-Hz under 1&2

- I Controller provides two levels of low-frequency limit monitoring for users to choose for warning, fault shutdown and control. If you select 1/2/3 alarm level when the protection function triggered, LCD screen displays "! W: GEN-Hz under 1" or "!W:GEN-Hz under 2"; if select 4/5/6 alarm level when protection function triggered, LCD screen display "! A: GEN-Hz under 1 " or " ! A: GEN-Hz under 2".

Function	Select "Y", the monitoring function is active; Select "N", the monitoring function is invalid.
Limit	Used to define low frequency protection threshold. When the generated voltage reaches or falls below this threshold, lasts time longer than the delay time, the define operation of alarm levels are triggered
Delay	If the generation low frequency exceeds the value of the delay time set, the define operation of alarm levels are triggered; if low frequency higher than the voltage limit in the delay before termination, the delay time is set to zero.
Start point	Defined time range of effective monitoring function: Set (0) : always effective;; Set (1) : starting from crank, monitoring effectively at the same time; Set (2) : from safety supervision delay time over, start effective;; Set (3) : after running ,start effectively.
Alarm levels	Used to define the protection is triggered, and what is the controller will do. Details refer to the alarm level configuration table.

GEN-Hz over 1&2

- I Controller provides two levels of high-frequency limit monitoring for users to choose for warning, fault shutdown and control. If you select 1/2/3 alarm level when the protection function triggered, LCD screen displays "! W: GEN-Hz over 1" or "! W: GEN-Hz over 2"; if select 4/5/6 alarm level when protection function triggered, LCD screen display"! A: GEN-Hz over 1" or "! A: GEN-Hz over 2".

Function	Select "1", the monitoring function is active; Select "0", the monitoring function is invalid.
Limit	Used to define high frequency protection threshold. When the generated voltage reaches or falls below this threshold, lasts time longer than the delay time, the define operation of alarm levels are triggered.
Delay	If the generation high frequency exceeds the value of the delay time set, the define operation of alarm levels are triggered; if high frequency higher than the voltage limit in the delay before termination, the delay time is set to zero.
Start point	Defined time range of effective monitoring function: Set (0) : always effective; Set (1) : starting from crank, monitoring effectively at the same time; Set (2) : from safety supervision delay time over, start effective Set (3) : after running ,start effectively.
Alarm levels	Used to define the protection is triggered, and what is the controller will do. Details refer to the alarm level configuration table.

GEN-I over 1&2

- I Controller provides two levels of overcurrent limit monitoring for users to choose for warning, fault shutdown and control. If you select 1/2/3 alarm level when the protection function triggered, LCD screen displays "! W: GEN-I over 1" or "! W:GEN-I over 2"; if select 4/5/6 alarm level when protection function triggered , LCD screen displays"! A: GEN-I over 1" or "! A: GEN-I over 2".

Function	Select "Y", the monitoring function is active; Select "N", the monitoring function is invalid.
Limit	Used to define overcurrent protection threshold. When the generated voltage reaches or falls below this threshold, lasts time longer than the delay time, the define operation of alarm levels are triggered.
Delay	If the generation overcurrent exceeds the value of the delay time set, the define operation of alarm levels are triggered; if overcurrent higher than the voltage limit in the delay before termination, the delay time is set to zero.
Start point	Defined time range of effective monitoring function: Set (0) : always effective; Set (1) : starting from crank, monitoring effectively at the same time; Set (2) : from safety supervision delay time over, start effective; Set (3) : after running ,start effectively
Alarm levels	Used to define the protection is triggered, and what is the controller will do. Details refer to the alarm level configuration table.

GEN-KW over 1&2

- I Controller provides two levels of overload monitoring for users to choose for warning, fault shutdown and control. If you select 1/2/3 alarm level when the protection function triggered, LCD screen displays "! W: GEN-KW over 1" or "! W: GEN-KW over 2"; if select 4/5/6 alarm level when protection function triggered, LCD screen displays "! A: GEN-KW over 1" or "! A: GEN-KW over 2"

Function	Select "Y", the monitoring function is active; Select "N", the monitoring function is invalid.
Limit	Used to define overload protection threshold. When the generated voltage reaches or falls below this threshold, lasts time longer than the delay time, the define operation of alarm levels are triggered.
Delay	If the generation overload exceeds the value of the delay time set, the define operation of alarm levels are triggered; if overload higher than the voltage limit in the delay before termination, the delay time is set to zero.
Start point	Defined time range of effective monitoring function: Set (0) : always effective; Set (1) : starting from crank, monitoring effectively at the same time; Set (2) : from safety supervision delay time over, start effective Set (3) : after running ,start effectively
Alarm levels	Used to define the protection is triggered, and what is the controller will do. Details refer to the alarm level configuration table.

Phase rotation

- I Voltage phase sequence according to clockwise and counterclockwise directions at different division, clockwise as "L1-L2-L3", to "CW" indicates; counterclockwise direction as "L1-L3-L2", to "CCW" indicates. The controller detects the voltage phase sequence measurement, if the control is set clockwise phase sequence and measured counterclockwise, or control settings and measured counterclockwise to clockwise, the protection function is triggered, LCD screen displays " failure: phase sequence mismatch ".

Monitor	Select "Y", the monitoring function is active; Select "N", the monitoring function is invalid.
Phase sequence	"0 CW" clockwise, the voltage sequence direction is "L1-L2-L3"; "1 CCW" counterclockwise, the voltage sequence direction is "L1-L3-L2".
Start point	Defined time range of effective monitoring function: Set (0) : always effective; Set (1) : starting from crank, monitoring effectively at the same time; Set (2) : from safety supervision delay time over, start effective Set (3) : after running ,start effectively.
Alarm levels	Used to define the protection is triggered, and what is the controller will do. Details refer to the alarm level configuration table.

GCB close

- I Controller can closing monito the GEN load switch for warning, fault shutdown and control. If you choose to 1/2/3 alarm level when the protection function triggered, LCD screen displays "!W:GCB close"; If you choose to 4/5/6 alarm level when protection function, LCD screen displays"! A: GCB close".

Function	Select "Y", the monitoring function is active; Select "N", the monitoring function is invalid.
Delay	When generator sended the GEN closing command, the delay timer starts to timing when the timer ends, the GEN load switch has not been closed or keep in the state of GEN closing switch command, the switch off, and the define operation of alarm levels are triggered.
Alarm levels	Used to define the protection is triggered, and what is the controller will do. Details refer to the alarm level configuration table.

GCB open

- I Controller can load switch of the power generation sub-gate monitoring, for users to choose for warning downtime and control. If you choose to 1/2/3 alarm level protection function triggered LCD screen displays "!W:GCB open"; such as select 4/5/6 alarm levels trigger protection function, the LCD screen displays "! A: GCB open".

Function	Select "Y", the monitoring function is active; Select "N", the monitoring function is invalid.
Delay	When generator sended the GEN closing command, the delay timer starts to timing when the timer ends, the GEN load switch has not been closed or keep in the state of GEN closing switch command, the switch close, and the define operation of alarm levels are triggered.
Alarm levels	Used to define the protection is triggered, and what is the controller will do. Details refer to the alarm level configuration table.



NOTE:

To make the monitoring function of the GEN closing and opening effectively, must satisfy at the same time :

- I One of the relay is defined as " GEN closing / opening";
- I One of D-input is defined as " GEN closing auxiliary contacts.

GEN. loading Volt

- I Used to define the voltage threshold of GEN can closing power supply.

GEN. loading Hz

- I Used to define the frequency threshold of GEN can closing power supply.

GEN. on delay

- I Used to set the delay time of the GEN auto closing power supply from load conditions are satisfy.

Test mode

- I Use for controller in the test mode, select the control function.
- I When the parameter is set to "0", the controller is running in test mode, generator running, the transfer switch not convert, mains continue to supply, and the generator unload running; When the parameter is set to "1", the control runs in test mode, generator running, the transfer switch conversion, and power supply.

Soft unload time

- I When the trigger alarm level is "3" shutdown fault, soft unload time start to timing ,and after the timing, GCB load switch opening.

7.3 ENGINE

No.	Parameter	Setting range	Preset
3.0	Quit		
3.1	Engine type	1 Diesel /2 ECU/3 Gas	1
3.2	ECU type	1 to 20	4
3.3	Engine rated speed	99 to 9999RPM	1500
3.4	MPU input	0 N/1 Y	0
3.5	Fly wheel teeth	5 to 300	120
3.6	Set pickup now		
3.7	Pair of poles	1 to 20	2
3.8	Fuel mode	0 N.C/1 N.O	0
3.9	Start delay	0 to 999s	10s
3.10	Crank attempts	1 to 10	3
3.11	Critical C-attempt	1 to 20 times	6 times
3.12	Crank time	1 to 99s	5s
3.13	Crank time add	1 to 99s / Not used	Not used
3.14	Crank pause time	1 to 300 秒	15s
3.15	Ignition speed	1 to 9999 RPM	200RPM
3.16	Ignition start DLY	1 to 999s	5s
3.17	Gas valve on DLY	0 to 999s	5s
3.18	Crank cutout RPM	1 to 9999 RPM	300RPM
3.19	Crank cutout volt	1 to 100% / Not used	85%
3.20	Crank cutout ALT-V	1.0 to 40.0 V / Not used	Not used
3.21	Crank cutout Oil-P	0.1 to 150.0Bar/PSI / Not used	2.2 Bar
3.22	Crank cutout P-DLY	1 to 60s / Not used	Not used
3.23	Idle time	1 to 9999s / Not used	Not used
3.24	Pre-heat mode	1 to 6	1
3.25	Pre-heat time	1 to 9999s / Not used	3s
3.26	Safety-on delay	0 to 600s	10s
3.27	Cool down mode	0 Full speed /1 Idle	1
3.28	Cool down time	0 to 9999s	300s
3.29	Stop time	0 to 60s	20s
3.30	EX. Crank permit	0 N/1 Y	0
3.31	Charge failure		
	Function	0 N/1 Y	1
	Limit	1.0 to 40.0 V	8.0V
	ALM. class	0 to 6	2
3.32	Pickup signal		
	Function	0 N/1 Y	1
	Delay	0 to 999s	1s
	Delay by	0 to 3	1
	ALM. class	0 to 6	2
3.33	Overspeed level1		
	Function	0 N/1 Y	1
	Limit	1 to 9999 RPM	1600 RPM
	Delay	0 to 999s	1s
	Delay by	0 to 3	1
	ALM. class	0 to 6	2

3.34	Overspeed level2		
	Function	0 N/1 Y	1
	Limit	1 to 9999 RPM	1710 RPM
	Delay	0 to 999s	0s
	Delay by	0 to 3	1
	ALM. class	0 to 6	6
3.35	Underspeed level1		
	Function	0 N/1 Y	1
	Limit	1 to 9999 RPM	1440RPM
	Delay	0 to 999s	5s
	Delay by	0 to 3	3
	ALM. class	0 to 6	2
3.36	Underspeed level2		
	Function	0 N/1 Y	0
	Limit	1 to 9999 RPM	1350 RPM
	Delay	0 to 999s	5s
	Delay by	0 to 3	3
	ALM. class	0 to 6	3
3.37	Start failure		
	Function	0 N/1 Y	1
	ALM. class	0 to 6	6
3.38	Stop failure		
	Function	0 N/1 Y	1
	ALM. class	0 to 6	3
3.39	Batt. Overvolt		
	Function	0 N/1 Y	1
	Limit	1.0 to 40.0 V	35.0 V
	Delay	0 to 999s	1s
	Delay by	0 to 3	0
	ALM. class	0 to 6	2
3.40	Batt. Undervolt		
	Function	0 N/1 Y	1
	Limit	1.0 to 40.0 V	8.0 V
	Delay	0 to 999s	1s
	Delay by	0 to 3	0
	ALM. class	0 to 6	2
3.41	Maintenance		
	Function	0 N/1 Y	0
	Limit	0 to 9999 hours	1000
	ALM. class	0 to 6	2
3.42	ECU Data fail		
	Function	0 N/1 Y	1
	Delay	0 to 999s	30s
	Delay by	0 to 3	3
	ALM. class	0 to 6	2
3.43	ECU Warning		
	Function	0 N/1 Y	1
		0 to 999s	5s
		0 to 3	3
		0 to 6	2

3.44	ECU Shutdown		
	Function	0 N/1 Y	1
	Delay	0 to 999s	5s
	Delay by	0 to 3	3
	ALM. class	0 to 6	6
3.45	Water in fuel		
	Function	0 N/1 Y	0
	Delay	0 to 999s	30s
	Delay by	0 to 3	3
	ALM. class	0 to 6	2

Menu description:**Engine type**

- I Used to select the controller controls the object type of engine.
- I When the parameter is set to "1", is a traditional diesel engine; When the parameter is set to "2", is used ECU of the engine; When the parameter is set to "3", is a conventional gas engine.
- I When the control object is ECU engine, the controller will be activated "ECU warning", "ECU fault shutdown", " ECU data failure" and "oil inlet water" protection function at the same time.
- I Diesel engine:

Starting sequence

Start-up delay start to time, time out, if preset preheating function, preheat relay closure outputs, warm-up time start to time, time out, throttle relay operation, the engine fuel solenoid valve opens, after delay 300 ms, crank relay closure outputs and start crank, when the engine operating speed reach crank cutting speed, crank stop, and the engine running.

If in cranking time timing period, the engine is not firing, crank stop, crank intermittent time begins and after the end of the timing, try to start the engine again. The boot sequence has been repeated until engine successfully ignition. When the number of starts reaches preset crank attempts, the controller will stop start control output, LCD display "failed to start".

Shutdown sequence:

After GCB Tripping, cooling time begin to time, time out, throttle relay action, the fuel solenoid valve is closed, engine stop. At the end of the engine downtime timing engine failed to stop, LCD displays "shutdown failed".

- I Gas engine:

Starting sequence:

The beginning of the start-up delay timing, time out, crank relay action, crank beginning, crank time and ignition delay time timer start at the same time, before the end of ignition start timing delay, the engine speed reaches or higher than the set ignition speed, ignition relay action, firing, the end of Gas valve open delay time open the gas valve when the engine operating speed reach the crank cutout RPM, crank stop, engine is running.

If after the end of ignition start timing delay, the engine speed has not reached the ignition speed, or crank time timing over, the engine still not ignition running, crank stop, crank rest timing start, try again to start engine after the end of the timing. The start sequence has been repeated until engine successfully ignition. When the number of starts reached the crank attempt of preset , controller will stop start control output, LCD displays "failed to start".

Shutdown sequence:

After GCB opening, cooling time starts timing, time out, the gas valve is closed, engine stopped, at the end of shutdown failed delay timing ignition stop..

At the end of shutdown failed delay timing, engine not stop, LCD displays "shutdown failed".

**Note:**

- I Normal shutdown procedure, you want to stop the ignition control output must be the engine shutdown. If the engine not shutdown after the end of shutdown fails delay timing, the engine has not been stopped, the ignition output will not stop.

- I Use to ECU engine, open and stop the process is controlled by the ECU, the controller can control the ECU power switch, and ECU open stop signal

ECU type

- I Used to define J1939 interface functions of controller and ECU type;
- I The controller has built-in several common ECU type:

Code	Description
1	Cummins GCS / (MODBUS) information
2	Cummins CM570 / Cummins QSX15 information
3	Cummins CM2150
4	VOLVO EMS2
5	Iveco
6	MTU
7	Scanis EMS S6

Engine rated speed

- I Used to define the rated speed of engine running;
- I As a baseline reference value of speed control.

MPU input

- I Used to define the controller whether using the speed sensor;
- I When the parameter is set to "1", the controller uses the speed sensor as the engine speed measurement signal source; When the parameter is set to "0", the controller of the engine speed measurement value from the frequency signal of the generator , the conversion was calculated;
- I Speed (RPM) and frequency conversion formula: speed (RPM) = (Hz * 60) / pole-pairs. Example: the measurement frequency of the generator is 50Hz, when the pole-pairs is set to 2, the speed (RPM) = (50 * 60) / 2 = 1500 (RPM).

Fly wheel teeth

- I Used to define the engine per revolution of pulses / flywheel teeth.

Set pickup now

- I If user not know the engine per revolution pulse / flywheel teeth, by measuring the frequency of power frequency and speed sensor, to calculate, obtained the number of flywheel teeth.;
- I flywheel teeth and power frequency conversion formula: flywheel teeth= (f1* pole-pairs) /f2, {f1 is speed sensor frequency, f2 is generating frequency };
- I Operating procedures:
 - Ø "Speed sensor input "parameter is set to" 0. "
 - Ø Start the generator, and enter to the "set the sensor frequency" setting menu, select the parameter "1", then press to confirm, then the menu "flywheel teeth" parameters automatically modified.
 - Ø "Speed sensor input "parameter is set to" 1 ", complete the relevant settings of speed sensor.

**NOTE:**

- I This function is only used for debugging process of controllers and generators..

Pair of poles

- I Used to define the generator exciter poles;
- I Controller speed measurement value from the frequency signal of the generator, for the measurement operation of speed.

Fuel mode

- I Use to configure the type of engine fuel supply valve (details refer to section 4.5).
- I N.C. type means the fuel channel when fuel can not be used: N.O. type means the fuel channel is opened when fuel can not be used.

Start delay

- I Used to define the time from satisfy conditions of the generator enable to the executing engine enable procedure.
- I This time is opened in the following conditions are valid:
 - Ø automatic operating mode, the remote signal is active.
 - Ø test mode is active.
- I When the start delay timer working, LCD screen displays the time course.

Crank attempts

- I The controller can repeatedly attempt to start the engine; the setting value is equal to the maximum crank times.

Critical C-attempt

- I When the critical mode is activated, the controller can repeatedly attempt to start the engine; the setting value is equal to the maximum crank times.

Crank time

- I Use to configure the time of duration of engine crank command issued.
- I This parameter is used in diesel engines, start to timing and the crank command issued at the same time; used on the gas engine, start to timing and the gas valve open command issued at the same time.

Crank time add

- I Used to adjust the time permit of the repeat cranking.
- I The second time of crank time is equal to the first crank time plus the extra time. For example: "crank time" set at 5s, "crank time add" set at 3s, then since the second crank, the maximum crank time permit is 8s.



Warning:

- I The maximum crank time permit can not exceed the range of the equipment safety.

Crank pause time

- I The time between last crank and next crank.
- I The time will be began in crank stop output, until the end of the time to re-issue the crank command.

Ignition speed

- I Used to define can be issue the minimum engine speed of Ignition command .
- I This parameter is valid only in the application of gas engine.

Ignition start DLY

- I Used to define the lag time of ignition output.
- I This parameter is only valid only on the application of the gas engine, crank command output and start to timing at the same time.

Gas valve on DLY

- I Used to define the lag time of gas valve open command issued.
- I This parameter is only valid only on the application of the gas engine from the ignition command issued and start to timing at the same time.

Crank cutout RPM

- I The crank cutout speed.

Crank cutout volt

- I The crank disconnect voltage.
- I Expressed by percentage, use “Rated ph-voltage” as factor.

Crank cutout ALT-V

- I The crank cutout charger voltage, signal is from the W/L terminal of charger;
- I When parameter is configured as “not used”, this function is inactive.

Crank cutout Oil-P

- I The crank cutout engine oil pressure, signal is from LOP-sensor.
- I When parameter is configured as “not used”, this function is inactive.

Crank cutout P-DLY

- I Used to configure the period from engine LOP-switch opened or oil pressure reaches oil Pressure Crank cutout value to crank disconnection.
- I When parameter is configured as “not used”, this function is inactive, also both being the condition of judging stop failure and can not implement crank process are inactive.

Idle time

- I The duration of engine idle running.
- I When controller in manual control mode, press the start button, the idle time timer starts to timing; when test control mode is valid, start delay timer end, idle time timer is beginning; when controller in the automatic control mode, the end of the start-up delay timer, idle time timer is started. Is defined within the idle time of idle output relay closed output ,time out, the relay restore the disconnected state.
- I When parameter is configured as “not used”, idle function is inactive.

Pre-heat mode

- I Used to configure the mode of preheat;
- I There are 7 pre-heat modes for selection, please read the description of preheat function for details.

Pre-heat time

- I The preheat duration before engine crank;
- I When parameter is configured as “not used”, pre-heat function is inactive.

Safety-on delay

- I Used to define the time from engine crank ignition successfully to Genset stable running;
- I The controller shielded low-speed, low voltage, low frequency, low oil pressure protection in the security monitoring delay time.



CAUTION:

- I Some of the protection are disabled during safety-on delay, so the safety-on delay should be set carefully and properly, this is very important, otherwise it may cause engine damage.

Cool down mode

- I Used to define the mode of cool down;
- I When parameter is configured as “0”, the engine will run at rated speed during cooling down. When parameter is configured as “1”, the engine will run in idle during cooling down.

Cool down time

- I The no-load run time allowed before the engine is stopped;
- I It is necessary to set cool down time, it can make the engine stop at a lower temperature after a long time running with load.

Stop time

- I The maximum time permit for the engine shutdown;
- I When the controller executes the stop command, that is, the fuel control relay is disconnected (the control relay closed output when the fuel is N.C). After the time out if the controller detects that the generator voltage is greater than the crank cutout voltage, or speed greater than the crank cutout speed, or oil pressure switch disconnected, or oil pressure is greater than the crank cutout oil pressure, then the shutdown failure;
- I In N.C fuel control, after the engine downtime time out, the fuel control relay disconnect output.

EX. Crank permit

- I Used to configure permit external crank to trigger the the normal controller monitoring, control and protection alarm function.
- I Refer to 4.8 for details.

Charge failure

- I Controller through the "WL" port detection auxiliary AC charger excitation voltage, to determine the AC charger whether working properly, when the detection voltage is lower than the set limit, charging failure protection function triggered. If you select 1/2/3 alarm level when protection function triggered, LCD displays "!W:Charge failure"; if select 4/5/6 alarm level when protection function triggered, LCD display "!W: Charge failure".

Function	Select "Y", the monitoring function is active; Select "N", the monitoring function is invalid.
Limit	Use to defined charging failure protection threshold. When detection voltage reaches or falls below this threshold, the duration exceeds over than delay time, the define operation of alarm levels are triggered.
Alarm levels	Used to define the protection is triggered, and what is the controller will do. Details refer to the alarm level configuration table.

Pickup signal

- I When using the speed sensor, the controller can through speed signal monitoring, to determine the speed sensor whether there is. When the sensor signal is lost, if select 1/2/3 alarm level when protection function triggered, LCD displays "!W:Pickup signal"; if select 4/5/6 alarm level when protection function triggered, LCD display "!A:Pickup signal"

Function	Select "Y", the monitoring function is active; Select "N", the monitoring function is invalid.
Delay	If the speed signal loss time of duration longer than the delay time value set, the define operation of alarm levels are triggered; if the speed signal loss recovery before the time delay termination, the delay time is set to zero.
Start point	Defined time range of effective monitoring function: Set (0) : always effective; Set (1) : starting from crank, monitoring effectively at the same time; Set (2) : from safety supervision delay time over, start effective Set (3) : after running ,start effectively.
Alarm levels	Used to define the protection is triggered, and what is the controller will do. Details refer to the alarm level configuration table.

Overspeed level1&2

- I Controller provides two levels of speed monitoring for users to choose for warning, fault shutdown and control. If you select 1/2/3 alarm level when the protection function triggered, LCD displays "!W:Overspeed level1" or "!W:Overspeed level2"; If you select 4/5/6 alarm level when protection function triggered, LCD displays"!A:Overspeed level1 "or"!A:Overspeed level 2.。

Function	Select "Y", the monitoring function is active; Select "N", the monitoring function is invalid.
Limit	Used to define the overspeed protection threshold. when the engine speed is at or above this threshold, time of duration over than delay time, the define operation of alarm levels are triggered.
Delay	If the overspeed time of duration over than the set time delay value, the define operation of alarm levels are triggered; if overspeed under the overspeed limit before delay stop, the delay time is set to zero.
Start point	Defined time range of effective monitoring function: Set (0) : always effective; Set (1) : starting from crank, monitoring effectively at the same time; Set (2) : from safety supervision delay time over, start effective Set (3) : after running ,start effectively.
Alarm levels	Used to define the protection is triggered, and what is the controller will do. Details refer to the alarm level configuration table.

Underspeed level1&2

- I Controller provides two levels of low-speed monitoring for users to choose for warning, fault shutdown and control. If you select 1/2/3 alarm level when the protection function triggered, LCD displays "!W:Underspeed level1" or "!W:Underspeed level2"; If you select 4/5/6 alarm level when protection function triggered, LCD display"!A:Underspeed level 1 "or"!A:Underspeed level 2.

Function	Select "Y", the monitoring function is active; Select "N", the monitoring function is invalid.
Limit	Used to define the low-speed protection threshold. when the engine speed is at or under this threshold, time of duration over than delay time, the define operation of alarm levels are triggered.
Delay	If the low-speed time of duration over than the set time delay value, the define operation of alarm levels are triggered; if low-speed under the low-speed limit before delay stop, the delay time is set to zero.
Start point	Defined time range of effective monitoring function: Set (0) : always effective; Set (1) : starting from crank, monitoring effectively at the same time; Set (2) : from safety supervision delay time over, start effective Set (3) : after running ,start effectively.
Alarm levels	Used to define the protection is triggered, and what is the controller will do. Details refer to the alarm level configuration table.

Start failure

- I If the engine number of start reaches a pre-set number of starts is still not running, which happened Startup Failure. If you select 1/2/3 alarm level when protection function triggered, LCD display "!W:Start failure"; if select 4/5/6 alarm level protection function triggered when LCD displays "!A:Start failure".

Function	Select "Y", the monitoring function is active; Select "N", the monitoring function is invalid.
Alarm levels	Used to define the protection is triggered, and what is the controller will do. Details refer to the alarm level configuration table..

Stop failure

- I When the controller executes the stop command, that is, the fuel control relay is disconnected (the control relay closed output when the fuel is N.C). After the time out if the controller detects that the generator voltage is greater than the crank cutout voltage, or speed greater than the crank cutout speed, or oil pressure switch disconnected, or oil pressure is greater than the crank cutout oil pressure, then the shutdown failure. If you select 1/2/3 alarm level when protection function triggered, LCD display "!W:Stop failure"; if select 4/5/6 alarm level when protection function triggered, LCD displays "!A:Stop failure

Function	Select "Y", the monitoring function is active. Select "N", the monitoring function is invalid.
Alarm levels	Used to define the protection is triggered, and what is the controller will do. Details refer to the alarm level configuration table.

Batt. overvolt

- I The controller detects the battery voltage, and provide a high limit protection for users to choose for warning, fault shutdown and control. If you select 1/2/3 alarm level when the protection function triggered, LCD displays "!W:Batt.Overvolt"; If select 4/5/6 alarm level when protection function triggered, LCD displays "!A:Batt.Overvolt.

Function	Select "Y", the monitoring function is active; Select "N", the monitoring function is invalid.
Limit	Used to define the high voltage protection threshold. when the battery voltage is at or over this threshold, time of duration over than delay time, the define operation of alarm levels are triggered.
Delay	If the high voltage time of duration over than the set time delay value, the define operation of alarm levels are triggered; if battery voltage under the high voltage limit before delay stop, the delay time is set to zero.
Start point	Defined time range of effective monitoring function: Set (0) : always effective; Set (1) : starting from crank, monitoring effectively at the same time; Set (2) : from safety supervision delay time over, start effective Set (3) : after running ,start effectively.
Alarm levels	Used to define the protection is triggered, and what is the controller will do. Details refer to the alarm level configuration table.

Batt. undervolt

- I The controller detects the battery voltage to provide a low-limit value of the protection, for the user to select for warning, downtime and control. If you select 1/2/3 alarm level when protection function triggered, LCD display "!W:Batt.Undervolt", If you select 4/5/6 alarm level when protection function triggered, LCD displays" !A:Batt.Undervolt.

Function	Select "Y", the monitoring function is active; Select "N", the monitoring function is invalid.
Limit	Used to define the low voltage protection threshold. when the battery voltage is at or over this threshold, time of duration over than delay time, the define operation of alarm levels are triggered.
Delay	If the low voltage time of duration over than the set time delay value, the define operation of alarm levels are triggered; if battery voltage over than the low voltage limit before delay stop, the delay time is set to zero..
Start point	Defined time range of effective monitoring function: Set (0) : always effective; Set (1) : starting from crank, monitoring effectively at the same time; Set (2) : from safety supervision delay time over, start effective Set (3) : after running ,start effectively.
Alarm levels	Used to define the protection is triggered, and what is the controller will do. Details refer to the alarm level configuration table.

Maintenance

- I The controller can be provided on the running time of the generator to be accumulated, and the default parameters with this comparison, there is provided a protection unit maintenance time limit for the user to select for warning, downtime and control. If you select 1/2/3 alarm level when protection function triggered, LCD displays "!W: maintenance"; if select 4/5/6 alarm level protection function triggered, LCD display" !A: maintenance".

Function	Select "Y", the monitoring function is active. Select "N", the monitoring function is invalid.
Limit	Use to definition of the threshold value of the maintenance days. When this parameter is set to the effective and start to accumulate the running time of the generator at the same time, when the cumulative time greater than this setting value, the define operation of alarm levels are triggered.
Alarm levels	Used to define the protection is triggered, and what is the controller will do. Details refer to the alarm level configuration table.

ECU Data fail

- I Controller and the the ECU communication on the engine, the delay time controller to accept less than the normal data from the ECU, to trigger an alarm action. If you select 1/2/3 alarm level when protection function triggered, LCD display "!W: ECU data failure"; if select 4/5/6 alarm level when protection function triggered, LCD display " !A : "ECU data failure".

Function	Select "Y", the monitoring function is active. Select "N", the monitoring function is invalid.
Delay	If the low voltage duration exceeds the set delay time value, the define operation of alarm levels are triggered, if the voltage over than the low voltage limit before delay stop, the delay time is set to zero..
Start point	Defined time range of effective monitoring function: Set (0) : always effective; Set (1) : starting from crank, monitoring effectively at the same time; Set (2) : from safety supervision delay time over, start effective Set (3) : after running ,start effectively.
Alarm levels	Used to define the protection is triggered, and what is the controller will do. Details refer to the alarm level configuration table.

**NOTE:**

- I When the engine shutdown, ECU closed, which means that is normal conditions, ECU no communication, but will not trigger fault protection.
- I This protection function effective when only choose the engine type "ECU".

ECU Warning

- I When the engine ECU shutdown, this is a warning level of fault, the engine continues to run, engine manufacturers sometimes called the "yellow alert". After receiving this signal, the controller can trigger an alarm action. If you select 1/2/3 alarm level when protection function triggered, LCD displays "!W: ECU warning"; if select 4/5/6 alarm level when protection function triggered, LCD display " !A: ECU warning".

Function	Select "Y", the monitoring function is active. Select "N", the monitoring function is invalid.
Delay	If the low voltage duration exceeds the set delay time value, the define operation of alarm levels are triggered, if the voltage over than the low voltage limit before delay stop, the delay time is set to zero.
Start point	Defined time range of effective monitoring function: Set (0) : always effective; Set (1) : starting from crank, monitoring effectively at the same time; Set (2) : from safety supervision delay time over, start effective Set (3) : after running ,start effectively.
Alarm levels	Used to define the protection is triggered, and what is the controller will do. Details refer to the alarm level configuration table.



NOTE:

- I ECU warning to the ECU itself is only a warning level of fault, the engine continues to run. If the controller uses this signal to trigger 4/5/6 alarm level, the control of the controller can turn off the engine.
- I This protection function effective when only choose the engine type "ECU".

ECU Shutdown

- I When the engine ECU shutdown failure, the engine shutdown, engine manufacturers, sometimes called "red light alarm. After receiving this signal, the controller can trigger an alarm action. If you select 1/2/3 alarm level when protection function triggered, LCD displays "!W: ECU shutdown fault; if select 4/5/6 alarm levels when protection function triggered, LCD display "!A: ECU downtime failure"

Function	Select "Y", the monitoring function is active.; Select "N", the monitoring function is invalid..
Delay	If the low voltage duration exceeds the set delay time value, the define operation of alarm levels are triggered, if the voltage over than the low voltage limit before delay stop, the delay time is set to zero.
Start point	Defined time range of effective monitoring function: Set (0) : always effective; Set (1) : starting from crank, monitoring effectively at the same time; Set (2) : from safety supervision delay time over, start effective Set (3) : after running ,start effectively.
Alarm levels	Used to define the protection is triggered, and what is the controller will do. Details refer to the alarm level configuration table.

Water in fuel

- I When the controller receives a signal from the ECU of oil influent, can trigger an alarm ation. If you select 1/2/3 alarm level when protection function triggered, LCD displays "!W: water in fuel "; if select 4/5/6 alarm levels when protection function is triggered, LCD displays" !A: water in fuel.

Function	Select "Y", the monitoring function is active; Select "N", the monitoring function is invalid.
Delay	If the low voltage duration exceeds the set delay time value, the define operation of alarm levels are triggered, if the voltage over than the low voltage limit before delay stop, the delay time is set to zero.
Start point	Defined time range of effective monitoring function: Set (0) : always effective; Set (1) : starting from crank, monitoring effectively at the same time; Set (2) : from safety supervision delay time over, start effective Set (3) : after running ,start effectively.
Alarm levels	Used to define the protection is triggered, and what is the controller will do. Details refer to the alarm level configuration table.



NOTE:

- I Controller received "water in fuel" of ECU signal, may also receive "ECU warning" or "ECU shutdown fault" signal at the same time.
- I This protection function effective when only choose the engine type "ECU".

7.4 Analog INPUT

No.	Parameter	Setting range	Preset
4.0	Quit		
4.1	P-sensor type	1 to 15 /not used	4
4.2	Oil-P low level1		
	Function	0 N/1 Y	1
	Limit	0.0 to 150.0 Bar/PSI	1.4Bar
	Delay	0 to 999s	1s
	Delay by	0 to 3	3
	ALM. class	0 to 6	2
4.3	Oil-P low level2		
	Function	0 N/1 Y	1
	Limit	0.0 to 150.0 Bar/PSI	1.1Bar
	Delay	0 to 999s	0s
	Delay by	0 to 3	3
	ALM. class	0 to 6	6
4.4	T-sensor type	1 to 15 / not used	3
4.5	High temp. level1		
	Function	0 N/1 Y	1
	Limit	50 to 320°C/°F	92°C
	Delay	0 to 999s	1s
	Delay by	0 to 3	3
	ALM. class	0 to 6	2
4.6	High temp. level2		
	Function	0 N/1 Y	1
	Limit	50 to 320°C/°F	100°C
	Delay	0 to 999s	0s
	Delay by	0 to 3	3
	ALM. class	0 to 6	6
4.7	Heater on level	-20 to 320°C/°F	50°C
4.8	Heater off level	-20 to 320°C/°F	60°C
4.9	Cooler on level	-20 to 320°C/°F	80°C
4.10	Cooler off level	-20 to 320°C/°F	70°C
4.11	AUX sensor1 use	0 not used /1 fuel /2 temp.	1
4.12	AUX sensor1 type	1 to 15	3
4.13	Low fuel level1		
	Function	0 N/1 Y	0
	Limit	0 to 100%	20%
	Delay	0 to 999s	1s
	Delay by	0 to 3	3
	ALM. class	0 to 6	2
4.14	Low fuel level 2		
	Function	0 N/1 Y	0
	Limit	0 to 100%	10%
	Delay	0 to 999s	1s
	Delay by	0 to 3	3
	ALM. class	0 to 6	2

4.15	High fuel level1		
	Function	0 N/1 Y	0
	Limit	0 to 100%	90%
	Delay	0 to 999s	1s
	Delay by	0 to 3	3
	ALM. class	0 to 6	2
4.16	High fuel level 2		
	Function	0 N/1 Y	0
	Limit	0 to 100%	100%
	Delay	0 to 999s	1s
	Delay by	0 to 3	3
	ALM. class	0 to 6	2
4.17	Fuel pump ON	0 to 100%	20%
4.18	Fuel pump OFF	0 to 100%	70%
4.19	AUX1 low T level1		
	Function	0 N/1 Y	0
	Limit	-20 to 320°C/°F	60°C
	Delay	0 to 999s	1s
	Delay by	0 to 3	3
	ALM. class	0 to 6	2
4.20	AUX1 low T level2		
	Function	0 N/1 Y	0
	Limit	-20 to 320°C/°F	50°C
	Delay	0 to 999s	1s
	Delay by	0 to 3	3
	ALM. class	0 to 6	2
4.21	AUX1 high T level1		
	Function	0 N/1 Y	0
	Limit	-20 to 320°C/°F	90°C
	Delay	0 to 999s	1s
	Delay by	0 to 3	3
	ALM. class	0 to 6	2
4.22	AUX1 high T level2		
	Function	0 N/1 Y	0
	Limit	-20 to 320°C/°F	100°C
	Delay	0 to 999s	1s
	Delay by	0 to 3	3
	ALM. class	0 to 6	2
4.23	Heater1 on level	-20 to 320°C/°F	50°C
4.24	Heater1 off level	-20 to 320°C/°F	60°C
4.25	Cooler1 on level	-20 to 320°C/°F	80°C
4.26	Cooler1 off level	-20 to 320°C/°F	70°C
4.27	AUX sensor2 use	0 not used /1 fuel /2 temp.	2
4.28	AUX sensor2 type	1 to 15	3
4.29	AUX2 low P level1		
	Function	0 N/1 Y	0
	Limit	0.0 to 150.0 Bar/PSI	1.1Bar
	Delay	0 to 999s	1s

	Delay by	0 to 3	3
	ALM. class	0 to 6	2
4.30	AUX2 low P level2		
	Function	0 N/1 Y	0
	Limit	0.0 to 150.0 Bar/PSI	1.4Bar
	Delay	0 to 999s	1s
	Delay by	0 to 3	3
	ALM. class	0 to 6	2
4.31	AUX2 high P level1		
	Function	0 N/1 Y	0
	Limit	0.0 to 150.0 Bar/PSI	8.0Bar
	Delay	0 to 999s	1s
	Delay by	0 to 3	3
	ALM. class	0 to 6	2
4.32	AUX2 high P level2		
	Function	0 N/1 Y	0
	Limit	0.0 to 150.0 Ba /PSI	10.0Bar
	Delay	0 to 999s	1s
	Delay by	0 to 3	3
	ALM. class	0 to 6	2
4.33	AUX2 low T level1		
	Function	0 N/1 Y	0
	Limit	-20 to 320°C/°F	60°C
	Delay	0 to 999s	1s
	Delay by	0 to 3	3
	ALM. class	0 to 6	2
4.34	AUX2 low T level2		
	Function	0 N/1 Y	0
	Limit	-20 to 320°C/°F	50°C
	Delay	0 to 999s	1s
	Delay by	0 to 3	3
	ALM. class	0 to 6	2
4.35	AU2 high T level1		
	Function	0 N/1 Y	0
	Limit	-20 to 320°C/°F	90°C
	Delay	0 to 999s	1s
	Delay by	0 to 3	3
	ALM. class	0 to 6	2
4.36	AUX2 high T level2		
	Function	0 N/1 Y	0
	Limit	-20 to 320°C/°F	100°C
	Delay	0 to 999s	1s
	Delay by	0 to 3	3
	ALM. class	0 to 6	2
4.37	Heater2 on level	-20 to 320°C/°F	50°C
4.38	Heater2 off level	-20 to 320°C/°F	60°C
4.39	Cooler2 on level	-20 to 320°C/°F	80°C
4.40	Cooler2 off level	-20 to 320°C/°F	70°C

Menu descriptions:**P-sensor type**

- I Used to define the type of pressure sensor.
- I The controller built-in a variety of pressure sensor types to choose,as follow:

Code	Mode	Note
0	Not used	
1	close for LOP	Closed (low) is valid
2	open for LOP	Open (high) is valid
3	VDO 5 bar	
4	VDO 10 bar	
5	Datcon 7 bar	
6	Murphy 7 bar	
7	Pre-set 1	
8	Pre-set 2	
9	Pre-set 3	
10	Pre-set 4	
11	Configurable 1	
12	Configurable 2	
13	Configurable 3	

Warning:

- I The P-sensor is used to measure the pressure, the measured pressure value for the engine low oil pressure protection function, the measurement accuracy related to the controller of the normal control and protection function is valid or not, so the correct choice of pressure sensor type or configurable sensor parameters is very important. Otherwise, it may cause damage to the engine.

- I The parameters appendix of LOP sensor:

VDO 5 bar:

P(Bar)	0	0.5	1.0	1.5	2.0	2.5	3.0	3.5	4.0	4.5	5
P(PSI)	0	7.3	14.5	21.8	29.0	36.3	43.5	50.8	58.0	65.3	72.5
R(Ω)	11	29	47	65	82	100	117	134	151	167	184

VDO 10 bar:

P(Bar)	0.0	1.0	2.0	3.0	4.0	5.0	6.0	7.0	8.0	9.0	10.0
P(PSI)	0	14.5	29.0	43.5	58.0	72.5	87.0	101.5	116.0	130.5	145.0
R(Ω)	10	31	52	71	90	106	124	140	155	170	184

Datcon 7 bar:

P(Bar)	0.0	0.7	1.4	2.1	2.8	3.4	4.1	4.8	5.5	6.2	6.9
P(PSI)	0	10.0	20.0	30.0	40.0	50.0	60.0	70.0	80.0	90.0	100.0
R(Ω)	240	200	165	135	115	95	78	63	48	35	25

Murphy 7 bar:

P(Bar)	0.0	0.7	1.4	2.1	2.8	3.4	4.1	4.8	5.5	6.2	6.9
P(PSI)	0	10.0	20.0	30.0	40.0	50.0	60.0	70.0	80.0	90.0	100.0
R(Ω)	240	205	171	143	123	103	88	74	60	47	33

Pre-set 1:

P(Bar)	0.0	1.0	2.0	3.0	4.0	5.0	6.0	7.0	8.0	9.0	10.0
P(PSI)	0	14.5	29.0	43.5	58.0	72.5	87.0	101.5	116.0	130.5	145.0
R(Ω)	15	31	49	66	85	101	117	132	149	164	178

Pre-set 2:

P(Bar)	0.0	1.0	2.0	3.0	4.0	5.0	6.0	7.0	8.0	9.0	10.0
P(PSI)	0	14.5	29.0	43.5	58.0	72.5	87.0	101.5	116.0	130.5	145.0
R(Ω)	30	41	65	88	110	115	145	150	172	185	190

Pre-set 3:

P(Bar)	0	1.7	3.4	5.2	6.9	8.6	10.3				
P(PSI)	0	25	50	75	100	125	150				
R(Ω)	21	36	52	72	84	100	120				

Pre-set 4:

P(Bar)	1.0	2.0	3.0	4.0	5.0	6.0	7.0	8.0	9.0		
P(PSI)	14.5	29.0	43.5	58.0	72.5	87.0	101.5	116.0	130.5		
R(Ω)	195	155	127	107	88	72	61	54	48		

**NOTE:**

- I “Configurable” means user can input the data manually according to the sensor parameter. Configurable 1 only can be set through the software; configurable 2 or 3 can be done through the push buttons on the front panel or software.
- I When configuring, please input the “resistance- measured value” from small to big one by one.

Oil-P low level 1&2

I Controller provides two levels of low oil pressure limit monitoring for users to choose for warning, fault shutdown and control. If you select 1/2/3 alarm level when protection function triggered, LCD displays " !W: Oil-P low level 1" or " !W: Oil-P low level 2"; if select 4/5/6 alarm levels, when protection function is triggered, LCD displays " !A: Oil-P low level 1" or " !A: Oil-P low level 2".

Function	Select "Y", the monitoring function is active; Select "N", the monitoring function is invalid.
Limit	Used to define the engine oil pressure protection threshold. when the engine oil pressure is at or under this threshold, time of duration over than delay time, the define operation of alarm levels are triggered.
Delay	If the engine oil pressure time of duration over than the set time delay value, the define operation of alarm levels are triggered; if the low oil pressure under than the low speed limit before delay stop, the delay time is set to zero.
Start point	Defined time range of effective monitoring function: Set (0) : always effective; Set (1) : starting from crank, monitoring effectively at the same time; Set (2) : from safety supervision delay time over, start effective Set (3) : after running ,start effectively.
Alarm levels	Used to define the protection is triggered, and what is the controller will do. Details refer to the alarm level configuration table.

T-sensor type

I Used to define the type of T-sensor .

I The controller built-in a variety of T-sensor types to choose,as follow:

Code	Mode	Note
0	Not used	
1	close for HET switch	Closed (low) is valid
2	open for HET switch	Disconnect (high) is valid
3	VDO 120°C	
4	VDO 150°C	
5	Datcon	
6	Murphy	
7	Pt100	
8	Pre-set 1	
9	Pre-set 2	
10	Pre-set 3	
11	Pre-set 4	
12	Configurable 1	
13	Configurable 2	
14	Configurable 3	

Caution:



I The T-sensor is used to measure the temperature, the measured temperature value for the engine high temperature protection function, the measurement accuracy related to the controller of the normal control and protection function is valid or not, so the correct choice of temperature sensor type or custom sensor parameters are very important. Otherwise, it may cause damage to the engine

I The parameters appendix of P-sensor:

VDO 120°C:

T(°C)	40	50	60	70	80	90	100	110	120	130	140
T(°F)	104	122	140	158	176	194	212	230	248	266	284
R(Ω)	291	197	134	97	70	51	38	29	22	18	15

VDO 150°C:

T(°C)	50	60	70	80	90	100	110	120	130	140	150
T(°F)	122	140	158	176	194	212	230	248	266	284	302
R(Ω)	322	221	155	112	93	62	47	37	29	23	19

Datcon:

T(°C)	40	50	60	70	80	90	100	110	120	130	140
T(°F)	104	122	140	158	176	194	212	230	248	266	284
R(Ω)	900	600	400	278	200	141	104	74	50	27	4

Murphy:

T(°C)	40	50	60	70	80	90	100	110	120	130	140
T(°F)	104	122	140	158	176	194	212	230	248	266	284
R(Ω)	1029	680	460	321	227	164	120	89	74	52	40

PT100:

T(°C)	-100	-50	0	20	40	60	80	100	150	200	300
T(°F)	-148	-58	32	68	104	140	176	212	302	392	572
R(Ω)	60	81	100	108	116	123	131	139	157	176	212

Pre-set 1:

T(°C)	20	30	40	50	60	70	80	90	100	110	120
T(°F)	68	86	104	122	140	158	176	194	212	230	248
R(Ω)	900	600	420	282	152	113	86	62	48	40	30

Pre-set 2:

T(°C)	30	50	60	70	80	90	100	110	120		
T(°F)	86	122	140	158	176	194	212	230	248		
R(Ω)	980	400	265	180	125	90	65	50	38		

Pre-set 3:

T(°C)	20	30	40	50	60	70	80	90	100	110	120
T(°F)	68	86	104	122	140	158	176	194	212	230	248
R(Ω)	805	540	380	260	175	118	83	58	42	30	21

Pre-set 4:

T(°C)	28	35	40	50	60	70	80	90	95	98	
T(°F)	82	95	104	122	140	158	176	194	203	208	
R(Ω)	579	404	342	250	179	136	103	77	67	63	



NOTE:

- I Configurable” means user can input the data manually according to the sensor curve. Configurable 1 only can be set through the software; configurable 2 or 3 can be done through the push buttons on the front panel or software.
- I When configuring, please input the “resistance-value” from small to big one by one.

High temp. level 1&2

- I Controller provides two levels of high-temperature limit monitoring for users to choose for warning, fault shutdown and control. If you select 1/2/3 alarm level when protection function triggered, LCD displays "!W: High temp. level 1 " or " !W:High temp. level 2"; if select 4/5/6 alarm level when protection function triggered, LCD display" !A: High temp. level1 " or " !A: High temp. level 2

Function	Select "Y", the monitoring function is active; Select "N", the monitoring function is invalid.
Limit	Used to define high temp protection threshold. when the engine temperature is at or higher than this threshold, time of duration over than delay time, the define operation of alarm levels are triggered.
Delay	If the high temp time of duration over than the set time delay value, the define operation of alarm levels are triggered; if the high temperature under than this limit before delay stop, the delay time is set to zero.
Start point	Defined time range of effective monitoring function: Set (0) : always effective; Set (1) : starting from crank, monitoring effectively at the same time; Set (2) : from safety supervision delay time over, start effective Set (3) : after running ,start effectively.
Alarm levels	Used to define the protection is triggered, and what is the controller will do. Details refer to the alarm level configuration table.

Heater on level

- I This parameter is used to set the controller to select the preheat mode 5 is defined as a " preheat " relay action of the temperature low- limit, and set " preheat control" relay action of the temperature low limi.
- I To This parameter is valid, the temperature sensor type can not be set to " not use" and "switch".

Heater off level

- I This parameter is used to set the controller to select the preheat mode 5 is defined as a " preheat " relay stop action of the high-temperature limit, and set " preheat control" relay stop action of the high-temperature limit.
- I To This parameter is valid, the temperature sensor type can not be set to "not use" and "switch"..

Cooler on level

- I This parameter is used to set is defined as a "cooling control" relay action of high temperature limit..
- I To This parameter is valid, the temperature sensor type can not be set to " not use" and "switch".

Cooler off level

- I This parameter is used to set is defined as a "cooling control" relay stop action of low temperature limit.
- I To This parameter is valid, the temperature sensor type can not be set to " not use" and "switch".

AUX sensor1 use

- I This parameter is used to set the auxiliary sensor port 1 function.
- I When the parameter is set to "0", this port is not used.
- I When the parameter is set to "1", this port connected P-sensor.
- I When the parameter is set to "2", this port connected temperature sensor..

AUX sensor1 type

- I Used to define the type of the auxiliary sensor 1.
- I When its oil level sensor, the controller built-in below oil level sensor types to choose, such as following the oil level sensor type table::

Code	Type	Remark
0	Not use	
1	close for LOL	Closed (low) is valid
2	open for LOL	Disconnect (high) is valid
3	configurable 1	
4	configurable 2	

- I When its temperature sensor, the controller built-in a variety of temperature sensor types to choose, refer to the temperature sensor type table.

Low fuel level 1&2

- I When the auxiliary sensor uses parameter is set to "1", this parameter is set to be effective.
- I Controller provides two levels of low oil level limit monitoring for users to choose for warning, fault shutdown and control. If you select 1/2/3 alarm level when protection function triggered, LCD displays "!W:Low fuel level1 " or "!W:Low fuel level2"; if select 4/5/6 alarm levels, when protection function is triggered, LCD displays "!A:Low fuel level1 or "!A:Low fuel level2".

Function	Select "Y", the monitoring function is active; Select "N", the monitoring function is invalid.
Limit	Used to define engine low oil level protection threshold. When the oil level is at or higher than this threshold, time of duration over than delay time, the define operation of alarm levels are triggered.
Delay	If the low oil level time of duration over than the set time delay value, the define operation of alarm levels are triggered; if the low oil level over than this limit before delay stop, the delay time is set to zero.
Start point	Defined time range of effective monitoring function: Set (0) : always effective; Set (1) : starting from crank, monitoring effectively at the same time; Set (2) : from safety supervision delay time over, start effective Set (3) : after running ,start effectively.
Alarm levels	Used to define the protection is triggered, and what is the controller will do. Details refer to the alarm level configuration table.

High fuel level 1&2

- I When the auxiliary sensor uses parameter is set to "1", this parameter is set to be effective;
- I The controller provides two levels of high oil level limit monitoring for users to choose for warning, fault shutdown and control. If you select A1/A2/A3 alarm level when protection function triggered, LCD displays "!W: High fuel level1 " or "!W: High fuel level2"; if select B1/B2/B3 alarm levels, when protection function is triggered, LCD displays "!A: High fuel level1 or "!A: High fuel level2.

Function	Select "Y", the monitoring function is active; Select "N", the monitoring function is invalid.
Limit	Used to define engine low oil level protection threshold. When the oil level is at or higher than this threshold, time of duration over than delay time, the define operation of alarm levels are triggered.
Delay	If the low oil level time of duration over than the set time delay value, the define operation of alarm levels are triggered; if the low oil level over than this limit before delay stop, the delay time is set to zero.
Start point	Defined time range of effective monitoring function: Set (0) : always effective; Set (1) : starting from crank, monitoring effectively at the same time; Set (2) : from safety supervision delay time over, start effective Set (3) : after running ,start effectively.
Alarm levels	Used to define the protection is triggered, and what is the controller will do. Details refer to the alarm level configuration table.

Fuel pump ON

- I When the parameter of AUX sensor 1 used is set to "1", this parameter is set to be effective.
- I This parameter is used to set is defined as "fuel pump control" relays closed of the fuel level low limit.
- I The controller through fuel sensor detects oil level of engine daily fuel tank, when the fuel is lower than the set value, "pump control" relay closure outputs.

Fuel pump OFF

- I When the parameter of AUX sensor 1 used is set to "1", this parameter is set to be effective.
- I This parameter is used to set is defined as "fuel pump control" relays closed of the fuel level high limit.
- I The controller through fuel sensor detects oil level of engine daily fuel tank, when the fuel is higher than the set value, "pump control" relay closure outputs.。

AUX1 low T level 1&2

- I When the auxiliary sensor 1 uses parameter is set to "2", this parameter is set to be effective..
- I Controller for auxiliary 1 temperature sensor provides two levels of the low-temperature limit monitoring for users to choose for warning, fault shutdown and control. If you select 1/2/3 alarm level when protection function triggered, LCD displays "!W:AUX 1 low T level1" or "!W:AUX 1 low T level 2"; if select 4/5/6 alarm levels, when protection function is triggered, LCD displays "!A:AUX1 low T level 1" or "!A:AUX1 low T level 2".

Function	Select "Y", the monitoring function is active; Select "N", the monitoring function is invalid.
Limit	Used to define auxiliary 1 T-sensor low limit protection threshold. When the temperature is at or lower than this threshold, time of duration over than delay time, the define operation of alarm levels are triggered.
Delay	If the low temperature time of duration over than the set time delay value, the define operation of alarm levels are triggered; if the temperature over than this limit before delay stop, the delay time is set to zero.
Start point	Defined time range of effective monitoring function: Set (0) : always effective; Set (1) : starting from crank, monitoring effectively at the same time; Set (2) : from safety supervision delay time over, start effective Set (3) : after running ,start effectively.
Alarm levels	Used to define the protection is triggered, and what is the controller will do. Details refer to the alarm level configuration table.

AUX1 high T level 1&2

- I When the auxiliary 1 sensor uses parameter is set to "2", this parameter is set to be effective.。
- I Controller to auxiliary 1 temperature sensor provides two levels of high-temperature limit monitoring for users to choose for a warning, fault shutdown and control. If you select 1/2/3 alarm level when protection function triggered, LCD displays "!W:AUX1 high T level1" or "!W:AUX1 high T level2"; if you select 4/5/6 alarm level when protection function is triggered, LCD displays "!A:AUX1 high T level1" or "!A:AUX1 high T level2"

Function	Select "Y", the monitoring function is active; Select "N", the monitoring function is invalid.
Limit	Used to define auxiliary 1 T-sensor high limit protection threshold. When the temperature is at or higher than this threshold, time of duration over than delay time, the define operation of alarm levels are triggered.
Delay	If the high temperature time of duration over than the set time delay value, the define operation of alarm levels are triggered; if the temperature under than this limit before delay stop, the delay time is set to zero.
Start point	Defined time range of effective monitoring function: Set (0) : always effective; Set (1) : starting from crank, monitoring effectively at the same time; Set (2) : from safety supervision delay time over, start effective Set (3) : after running ,start effectively.
Alarm levels	Used to define the protection is triggered, and what is the controller will do. Details refer to the alarm level configuration table.

Heater1 on level

- I This parameter is used to set the controller to select the preheat mode 6 is defined as a " preheat " relay action of the temperature low limit, and set " preheat 1 control" relay action of the temperature low limit.
- I To this parameter effective, the auxiliary sensor 1 type can not be set to " not use" and "switch".

Heater1 off level

- I This parameter is used to set the controller to select the preheat mode 6 is defined as a " preheat " relay stop action of the temperature high limit, and set " heat 1 control" relay stop action of the temperature high limit..
- I To this parameter is effective, the auxiliary sensor 1 type can not be set to " not use" and "switch".

Cooler1 on level

- I This parameter is used for setting is defined as a "cooling 1 control "relay action of in the temperature high limit.
- I To This parameter is valid, auxiliary temperature sensor types can not be set to " not use" and "switch".

Cooler1 off level

- I This parameter is used to set is defined as a "cooling 1 control" relay to stop the action of temperature low limit.
- I To This parameter is valid, auxiliary temperature sensor types can not be set to " not use" and "switch".

AUX sensor2 use

- I This parameter is used to set the auxiliary sensor port 2 function.
- I When the parameter is set to "0", this port is not used.
- I When the parameter is set to "1", this port connected P-sensor.
- I When the parameter is set to "2", this port connected temperature sensor.

AUX sensor2 type

- I Used to define the type of the auxiliary sensor 2.
- I As temperature sensor, the controller built a variety of T-sensor type to choose, refer the temperature sensor type table.
- I As P-sensor, the controller built a variety of P-sensor type to choose, refer the P-sensor type table.

AUX2 low P level 1&2

- I When the auxiliary sensor 2 uses parameter is set to "1", this parameter is set to be effective.
- I Controller for auxiliary 2 P-sensor provides two levels of the low- pressure limit monitoring for users to choose for warning, fault shutdown and control. If you select 1/2/3 alarm level when protection function triggered, LCD displays "!W:AUX 2 low P level1" or "!W:AUX 2 low P level 2"; if select 4/5/6 alarm levels, when protection function is triggered, LCD displays "! A: AUX 2 low T level 1" or " ! A: AUX 2 low P level 2.

Function	Select "Y", the monitoring function is active; Select "N", the monitoring function is invalid.
Limit	Used to define auxiliary 2 P-sensor low limit protection threshold. When the pressure is at or lower than this threshold, time of duration over than delay time, the define operation of alarm levels are triggered.
Delay	If the low pressure time of duration over than the set time delay value, the define operation of alarm levels are triggered; if the pressure over than this limit before delay stop, the delay time is set to zero.
Start point	Defined time range of effective monitoring function: Set (0) : always effective; Set (1) : starting from crank, monitoring effectively at the same time; Set (2) : from safety supervision delay time over, start effective Set (3) : after running ,start effectively.
Alarm levels	Used to define the protection is triggered, and what is the controller will do. Details refer to the alarm level configuration table.

AUX2 high P level 1&2

- I When the auxiliary sensor 2 uses parameter is set to "1", this parameter is set to be effective.
- I Controller for auxiliary 2 P-sensor provides two levels of the high-pressure limit monitoring for users to choose for warning, fault shutdown and control. If you select 1/2/3 alarm level when protection function triggered, LCD displays "!W:AUX 2 high P level1" or "!W:AUX 2 high P level 2"; if select 4/5/6 alarm levels, when protection function is triggered, LCD displays "!A:AUX 2 high P level 1" or "!A:AUX 2 high P level 2.

Function	Select "Y", the monitoring function is active; Select "N", the monitoring function is invalid.
Limit	Used to define auxiliary 2 P-sensor low limit protection threshold. When the pressure is at or lower than this threshold, time of duration over than delay time, the define operation of alarm levels are triggered.
Delay	If the high pressure time of duration over than the set time delay value, the define operation of alarm levels are triggered; if the pressure over than this limit before delay stop, the delay time is set to zero.
Start point	Defined time range of effective monitoring function: Set (0) : always effective; Set (1) : starting from crank, monitoring effectively at the same time; Set (2) : from safety supervision delay time over, start effective Set (3) : after running ,start effectively.
Alarm levels	Used to define the protection is triggered, and what is the controller will do. Details refer to the alarm level configuration table.

AUX2 low T level 1&2

- I When the auxiliary sensor 2 uses parameter is set to "2", this parameter is set to be effective.
- I Controller for auxiliary 2 temperature sensor provides two levels of the low-temperature limit monitoring for users to choose for warning, fault shutdown and control. If you select 1/2/3 alarm level when protection function triggered, LCD displays "!W:AUX 2 low T level1" or "!W:AUX 2 low T level 2"; if select 4/5/6 alarm levels, when protection function is triggered, LCD displays "!A:AUX 2 low T level 1" or "!A:AUX 2 low T level 2.

Function	Select "Y", the monitoring function is active; Select "N", the monitoring function is invalid.
Limit	Used to define auxiliary 2 T-sensor low limit protection threshold. When the temperature is at or lower than this threshold, time of duration over than delay time, the define operation of alarm levels are triggered.
Delay	If the low temperature time of duration over than the set time delay value, the define operation of alarm levels are triggered; if the temperature over than this limit before delay stop, the delay time is set to zero.
Start point	Defined time range of effective monitoring function: Set (0) : always effective; Set (1) : starting from crank, monitoring effectively at the same time; Set (2) : from safety supervision delay time over, start effective Set (3) : after running ,start effectively.
Alarm levels	Used to define the protection is triggered, and what is the controller will do. Details refer to the alarm level configuration table.

AUX2 high T level 1&2

- I When the auxiliary 2 sensor uses parameter is set to "2", this parameter is set to be effective.
- I Controller to auxiliary 2 temperature sensor provides two levels of high-temperature limit monitoring for users to choose for a warning, fault shutdown and control. If you select 1/2/3 alarm level when protection function triggered, LCD displays " !W: AUX 2 high T level1" or " !W: AUX 2 high T level 2"; if you select 4/5/6 alarm level when protection function is triggered, LCD displays " !A: AUX1 high T level1" or " !A: AUX 2 high T level 2"

Function	Select "Y", the monitoring function is active; Select "N", the monitoring function is invalid.
Limit	Used to define auxiliary 2 T-sensor high limit protection threshold. When the temperature is at or higher than this threshold, time of duration over than delay time, the define operation of alarm levels are triggered.
Delay	If the high temperature time of duration over than the set time delay value, the define operation of alarm levels are triggered; if the temperature under than this limit before delay stop, the delay time is set to zero.
Start point	Defined time range of effective monitoring function: Set (0) : always effective; Set (1) : starting from crank, monitoring effectively at the same time; Set (2) : from safety supervision delay time over, start effective Set (3) : after running ,start effectively.
Alarm levels	Used to define the protection is triggered, and what is the controller will do. Details refer to the alarm level configuration table.

Heater2 on level

- I This parameter is used to set the controller to select the preheat mode 7 is defined as a " preheat " relay action of the temperature low limit, and set " preheat 2 control" relay action of the temperature low limit.
- I To this parameter effective, the auxiliary sensor 1 type can not be set to " not use" and "switch".

Heater2 off level

- I This parameter is used to set the controller to select the preheat mode 7 is defined as a " preheat " relay stop action of the temperature high limit, and set " heat 2 control" relay stop action of the temperature high limit.
- I To this parameter is effective, the auxiliary sensor 1 type can not be set to " not use" and "switch",

Cooler2 on level

- I This parameter is used for setting is defined as a "cooling 2 control "relay action of in the temperature high limit.
- I To This parameter is valid, auxiliary temperature sensor 2 types can not be set to " not use" and "switch".

Cooler2 off level

- I This parameter is used to set is defined as a "cooling 2 control" relay to stop the action of temperature low limit.
- I To This parameter is valid, auxiliary temperature sensor 2 types can not be set to " not use" and "switch".

7.5 Discrete IN/OUT

No.	Parameter	Setting range	Preset
5.0	Quit		
5.1	D-Input 1 config		
	Function	0 to 30	6
	Logic	0 Closed/1 Open	0
	Delay	0 to 999s	1s
	Delay by	0 to 3	0
	ALM. class	0 to 6	6
5.2	D-Input 2 config		
	Function	0 to 30	2
	Logic	0 Closed/1 Open	0
	Delay	0 to 999s	1s
	Delay by	0 to 3	0
	ALM. class	0 to 6	6
5.3	D-Input 3 config		
	Function	0 to 30	3
	Logic	0 Closed/1 Open	0
	Delay	0 to 999s	1s
	Delay by	0 to 3	0
	ALM. class	0 to 6	6
5.4	D-Input 4 config		
	Function	0 to 30	4
	Logic	0 Closed/1 Open	0
	Delay	0 to 999s	1s
	Delay by	0 to 3	0
	ALM. class	0 to 6	6
5.5	D-Input 5 config		
	Function	0 to 30	0
	Logic	0 Closed/1 Open	0
	Delay	0 to 999s	1s
	Delay by	0 to 3	0
	ALM. class	0 to 6	6
5.6	D-Input 6 config		
	Function	0 to 30	0
	Logic	0 Closed/1 Open	0
	Delay	0 to 999s	1s
	Delay by	0 to 3	0
	ALM. class	0 to 6	6
5.7	D-Input 7 config		
	Function	0 to 30	0
	Logic	0 Closed/1 Open	0
	Delay	0 to 999s	1s
	Delay by	0 to 3	0
	ALM. class	0 to 6	6
5.8	Relay 1 Config		
	Function	0 to 120	2
	Logic	0 N.O/1 N.C	0

5.9	Relay 2 Config		
	Function	0 to 120	1
	Logic	0 N.O/1 N.C	0
5.10	Relay 3 Config		
	Function	0 to 120	0
	Logic	0 N.O/1 N.C	0
5.11	Relay 4 Config		
	Function	0 to 120	0
	Logic	0 N.O/1 N.C	0
5.12	Relay 5 Config		
	Function	0 to 120	0
	Logic	0 N.O/1 N.C	0
5.13	Relay 6 Config		
	Function	0 to 120	0
	Logic	0 N.O/1 N.C	0
5.14	Relay 7 Config		
	Function	0 to 120	0
	Logic	0 N.O/1 N.C	0
5.15	Relay 8 Config		
	Function	0 to 120	0
	Logic	0 N.O/1 N.C	0

Menu descriptions:

D-Input * Config

I Used to define the D-input function.

Function	Defined the function of discrete input, controller built-in a variety of functions for user to choose, as follows "definable D-input function menu.
logic	Select "0", the discrete input is active in close (low level); Select "1", the discrete input is active in open circuit.
Delay	If the discrete input is valid duration time over than the set delay time value, the define operation of alarm levels are triggered; if the discrete input change to invalid before delay stop, the delay time is set to zero.
Start point	Defined time range of effective monitoring function: Set (0) : always effective; Set (1) : starting from crank, monitoring effectively at the same time; Set (2) : from safety supervision delay time over, start effective Set (3) : after running ,start effectively.
Alarm levels	Used to define the protection is triggered, the controller action. Details see the alarm level table.



NOTE:

I Only in the function is set to "1", that is, when the discrete input function user-defined parameters of the delay, start point and alarm level is set to be effective.

I Configure D-input menu is as follows:

code	Function	Note
0	Not used	
1	User configured	When you select this function, the user can use the discrete input user- configured menu to configuration this function of discret.
2	Oil pressure switch	Select this function of discrete input port external one mounted pressure switch which is on the engine, and through this limit action switch to trigger the engine low oil pressure protection. The controller allows the oil pressure switch as a low oil pressure protection and the pressure sensor is measured as an engine low oil pressure protection simultaneously. Low oil pressure triggered by the alarm level, according to the low oil pressure alarm level 2 configuration table has been defined function to choose.
3	Temp. high switch	Select this function of discrete input port external one mounted temperature switch which is on the engine, and through this limit action switch to trigger the engine high temperature protection. The controller allows the temperature switch as a high temperature protection and the temperature sensor is measured as an engine high temperature protection simultaneously. High temperature triggered by the alarm level, according to the high temperature alarm level 2 configuration table has been defined function to choose.

4	Emergency stop	Select this function of discrete input port external an emergency stop switch, when this input valid, the controller close all control output, trigger the alarm level "6", the engine shutdown immediate.
5	Remote off load	This input is active, the generator start-up, power generation does not issue a closing command after normal operation, has been unload operation until the input signal becomes invalid. This signal is only valid in auto .
6	Remote with load	For GM6650 controllers, this input is active, the generator starting, after normal operation, power generation issue a closing command, and has been maintained until the input signal becomes invalid. For GM6651 controllers, this input is active, the generator start running normal, if the mains normal load, the controller not issue closing command;, if the mains not normal and opening, the controller sends power generation close command. This signal is only valid in auto .
7	Mains closed auxiliary	Select this function of discrete input port connected to the MCB auxiliary contacts of mains load switch, for monitoring the status of the closing or opening of the MCB. Only on GM6651 controllers valid.
8	GEN closed auxiliary	Select this function of discrete input port connected to the GCB auxiliary contacts of mains load switch, for monitoring the status of the closing or opening of the GCB
9	Low fuel switch	Select this function of discrete input port connected to the fuel tank of the engine oil level switch for monitoring the fuel tank low oil level.
10	Lamp test	Select this function of discrete input signal is active, the indicator light on the controller operation panel all illuminate. The function equivalent to the control panel "lamp test" button.
11	Lower speed limit	Select this function of discrete input signal is active, the controller will not issues a deceleration signal.
12	Raise speed limit	Select this function of discrete input signal is active, the controller will not issues an acceleration signal.
13	Air-flap Closed	Select this function of discrete input port connected to the auxiliary contacts on the engine ventilation door, and through the limit actions of switch to determine the ventilation door working conditions.
14	Pre-heat switch	Select this function of discrete input port connected to the temperature switch which is mounted on the engine preheater, and through the limit action of switch to stop preheat relay output. Only for the Preheat mode 4
15	Critical mode	In critical mode, all the shutdown fault change to warning, that is when the unit in shutdown fault, only alarm not to shutdown. LCD display critical mode.
16	Alarm mute	When selecting this digital input signal of function is active, the alarm buzzer of controller will stop sound, one is defined as "sound alarm" relay output will be closed. The functionality of input signal is equivalent to the the "mute" button on the controller panel.

17	Alarm reset	Select this function discrete input signal is active, the controller shutdown fault lock will unlock.
18	Prohibit return	When selecting this digital input signal of function is active, Generator for the remote open signal effectively and mains fault while start and load, when mains is restored to normal, the controller will continue to control the generator running and load until the return signal removed , or occurrence of shutdown fault. The LCD displays limited return information. This input is only supply for GM6651 controll.
19	Mutual standb	With this function of the D-input signal, the two controllers can be combined into a standby power supply system. For details, please refer to the description of the functions of mutual standby.
20	Panel lock	When selecting this digital input signal of function is active, you can not modify the operating parameters on the operation panel of the controller, can not select the operating mode of the controller. LCD display panel lock information.
21	Activate AUTO mode	When selecting this digital input signal of function is active, the controller change to auto operation mode, which provides users with a remote button to select auto operation mode. This operating mode selection function is not affected by panel lock.
22	Activate MAN mode	When selecting this digital input signal of function is active, the controller change to manual operation mode, which provides users with a remote button to select manual operation mode. This operating mode selection function is not affected by
23	Activate TEST mode	When selecting this digital input signal of function is active, the controller change to test operation mode, which provides users with a remote button to select test operation mode. This operating mode selection function is not affected by panel lock.
24	Stop button	Select this function, the discrete input signal function is equivalent to control panel "stop" button, it provides users with a remote stop buttons.
25	Start button	Select this function, the discrete input signal function is equivalent to control panel "start" button, it provides users with a remote start buttons.
26	Inhibit Genset	When selecting this digital input signal of function is active, the controller disables power generation.
27	Low water level	When selecting this digital input signal of function is active, the controller has a low water level alarm, the corresponding alarm levels and delay settings are valid.
28	Gas leakage1	When selecting this digital input signal of function is active, the controller has gas leak alarm 1, the corresponding alarm levels and delay settings are valid.
29	Gas leakage2	When selecting this digital input signal of function is active, the controller has gas leak alarm 2, the corresponding alarm levels and delay settings are valid.
30	Fire	When selecting this digital input signal of function is active, the controller has fire alarm, the corresponding alarm levels and delay settings are valid.

Relay * config

I Use to configure the relay function selection.

Function	Define the role of the relay output, controller built-in a variety of functions for the user to choose, as follows " configure relay output menu".
Logic	Select " 0", the monitoring function is active; Select " 1", the monitoring function is invalid.

I Configure relay output function table:

code	Function	Note
0	Not used	
1	Crank	Select this function of the output relay is used to control the engine starter motor, when need the engine crank, its running, stop in crank cutout conditions are satisfy.
2	Fuel	Select this function of the output relay is used to control the diesel engine throttle electromagnet, when need to start the engine, its running, stop in crank cutout conditions are satisfy.
3	Gas valve	Select this function of the output relay is used to control the gas engine fuel valve closed or open, when need to start the engine, its running, stop in crank cutout conditions are satisfy.
4	Ignition	Select this function of the output relay is used to control the gas engine ignition system provides power or signal, when to achieve ignition conditions, its running, stop running in ignition stop delay timing over.
5	Shutdown alarm	Select this function of the output relay running when occurrence of one or more of shutdown fault, after fault clearance and press the fault reset, then its stop.
6	Warning	Select this function of the output relay running when occurrence of one or more of warning, after fault clearance, its stop.
7	Idle	Select this function of the output relay action, in controller internal idle time timing period, stop working in the end of timing.
8	Preheat output	Select the function of the output relay action, please refer to the description of preheating function.
9	Speed raise	Select this function of the output relay, when the engine speed running speed is lower than the rated speed will be action, this is a pulse speed control signal.
10	Speed lower	Select this function of the output relay, when the engine speed running speed is higher than the rated speed will be action, this is a pulse speed control signal.
11	Fuel pump control	Select this function of output relay action when the fuel level is lower than the setting of lower limit of the pump open level value, and keep until the setting of high limit of fuel level reaches the pump stop level value.
12	Genset running	Select this function of the output relays action when the generator is normal running, that is the engine speed, oil pressure, temperature, etc., and the electrical parameters of the generator have reached the limits of the normal setting.

13	Auto mode	output relay action, when controller running in the auto operation mode.
14	Test mode	output relay action, when controller running in the test operation mode.
15	Man mode	output relay action, when controller running in the manual operation mode.
16	Maintenance due	Select this function of output relay, the accumulation time of engine reaches the time limit value of maintenance parameter set, it s action, and stopping action in the re-set maintenance time or press the reset button.
17	MCB fail to close	Output relay action, after the mains closing failure occurred. Only supply for GM821/GM831 controller.
18	GCB fail to close	Output relay action, after the generator closing failure occurred .
19	Fail to start	The crank attempts of engine reaches the setting have been not successful ignition, the output relay action.
20	Fail to stop	The engine is still running after the end of the downtime timing set, the output relay action.
21	Mains close/open	The output relay is used to control the mains load switch GCB closing and opening action, when the controller commands mains supply power, its action, and not need the mains supply power, its stop working.
22	GEN close/open	The output relay is used to control the power generation load switch GCB closing and opening action, when the controller commands power generation supply, its action,
23	Audible alarm	When you need on the basis of the controller built-in alarm buzzer add a warning sound, the output relay action be equal to built-in alarm buzzer.
24	Cooling down	output relay action, in timing of the cooling time.
25	ECU data fail	At the end of the safety monitoring time timing has not receive the data from engine ECU, choose this function of the output relay action.
26	ECU warning	The output relay operation of select this function when receive the warning signal from ECU
27	ECU alarm	The output relay operation of select this function when receive the fault signal from ECU
28	Charge failure	When charging failure occurs, the output relay action.
29	Batt over volt	when the controller detects that the battery voltage is higher than the set value, its action.
30	Batt under volt	When the controller detects that the battery voltage is lower than the set value, its action.

31	Underspeed level1	When the engine speed is lower than the setting of under speed level 1 while delay confirm, its action.
32	Underspeed level 2	When the engine speed is lower than the setting of under speed level 2 while delay confirm, its action.
33	Overspeed level1	When the engine speed is higher than the setting of overspeed level 1 while delay confirm, its action.
34	Over speed level2	When the engine speed is higher than the setting of over speed level 2 while delay confirm, its action.
35	Oil-P low level1	When the engine oil pressure lower than the setting of low oil level 1 while delay confirm, its action..
36	Oil-P low level2	When the engine oil pressure lower than the setting of low oil level 2 while delay confirm, its action..
37	High temp. level1	When the cooling temperature of engine is higher than the setting of high temperature level 1 while delay confirm, its action.
38	High temp. level 2	When the cooling temperature of engine is higher than the setting of high temperature level 2 while delay confirm, its action.
39	Fuel low level1	When the engine fuel level lower than the setting of low oil level 1 while delay confirm, its action.
40	Fuel low level2	When the engine fuel level lower than the setting of low oil level 2 while delay confirm, its action.
41	GEN-V under 1	When the generator voltage is lower than the setting of the power generation of low voltage level 1 while delay confirm, its action.
42	GEN-V under 2	When the generator voltage is lower than the setting of the power generation of low voltage level 2 while delay confirm, its action.
43	GEN-V over 1	When the generator voltage is higher than the setting of power generation of high-voltage level 1 while delay confirm, its action.
44	GEN-V over 2	When the generator voltage is higher than the setting of power generation of high-voltage level 2 while delay confirm, its action.
45	GEN-Hz under 1	When the generator frequency is lower than the setting of power generation of low-frequency level 1 while delay confirm, its action.
46	GEN-Hz under 2	When the generator frequency is lower than the setting of power generation of low-frequency level 2 while delay confirm, its action.
47	GEN-Hz over 1	When the generator frequency is higher than the setting of power generation of high-frequency level 1 while delay confirm, its action.
48	GEN-Hz over 2	When the generator frequency is higher than the setting of power generation of high-frequency level 2 while delay confirm, its action.

49	GEN-I over 1	When the generator current is higher than the setting of current level 1 while delay confirm, its action.
50	GEN-I over 2	When the generator current is higher than the setting of current level 2 while delay confirm, its action.
51	GEN-KW over 1	When the active load of engine is higher than the setting of power generation overload level 1 while delay confirm, its action.
52	GEN-KW over 2	When the active load of engine is higher than the setting of power generation overload level 2 while delay confirm, its action.
53	Idle 1	Select this function of output relay, for 1 second after the end of the idle time in the controller,
54	Idle 2	Select this function of output relay, for 1 second after the start of the cooling time in the controller,
55	Reserve	
56	Reserve	
57	Reserve	
58	Reserve	
59	Reserve	
60	Mutual standby	Select this function to connect the output relay to other controllers as defined as a dual-mutual standby discrete input port to complete the dual-mutual standby function.
61	Oil-P sensor open	Select this function of the output relays action after the controller detect oil pressure sensor. The triggered alarm level is defined by the low oil pressure alarm level 2.
62	Loss of pickup	When select the speed sensor as the engine speed control signal, in crank command is issued, undetectable speed sensor signal, the function of the output relay action.
63	Scheduled run	Select this function if the output relay is valid in regularly run, its action.
64	Blinds control	Select this function of output relay at the beginning of the start time delay, its action, and stop after the engine stops running. This output is connected to the electric shutter of engine cooling air duct, control the blinds open and close.
65	Cooler control	Select this function of output relay, when the cooling temperature of engine is higher than the lower limit of cooling open level value of setting, its action, and keep until the cooling temperature lower than the high limit of the preheat stop level of setting, its stop.

66	Cooler1 control	Select this function of output relay, when from auxiliary temperature sensor 1 measuring the temperature is higher than the low limit of cooling 1 open level level value of setting, its action, and keeping until the temperature is lower than the high limit of cooling 1 stop level value of setting, its stop action.
67	Cooler2 control	Select this function of output relay, when from auxiliary temperature sensor 1 measuring the temperature is higher than the low limit of cooling 2 open level level value of setting, its action, and keeping until the temperature is lower than the high limit of cooling 2 stop level value of setting, its stop action.
68	Heater control	Select this function of output relay, when the cooling temperature of engine is below the lower limit of preheat open level value of setting, its action, and keep until the cooling temperature higher than the high limit of the preheat stop level of setting, its stop
69	Heater1 control	Select this function of output relay, when from auxiliary temperature sensor 1 measuring the temperature is lower than the low limit of preheat 1 open level level value of setting, its action, and keeping until the temperature is higher than the high limit of preheat 1 stop level value of setting, its stop action.
70	Heater2 control	Select this function of output relay, when from auxiliary temperature sensor 1 measuring the temperature is lower than the low limit of preheat 2 open level level value of setting, its action, and keeping until the temperature is higher than the high limit of preheat 2 stop level value of setting, its stop action.
71	GCB open	This output relay is connected to the shut excitation coil of generate power load switch MCB, when controller command of generate power to outage, stopped working
72	MCB open	This output relay is connected to the shut excitation coil of mains load switch MCB, when controller command of mains to outage, stopped working after the switch opening.
73	Mains V low alarm	When the mains voltage is lower than the set value while trigger fault, its actions.
74	Mains V high alarm	When the mains voltage is higher than the set value while trigger fault, its actions.
75	Mains Hz low alarm	When the mains frequency is lower than the set value while trigger fault, its actions.
76	Mains Hz high alarm	When the mains frequency is higher than the set value while trigger fault, its actions.
77	Mains alarm	When mains low frequency, high frequency, low voltage and high voltage, any more than the set limit while trigger fault, its actions.
78	Mains overload	When the controller occurs mains overload fault action.
79	Mains overcurrent	When the controller occurs mains overcurrent fault action.
80	Soft unload	When soft unloading time start timing action, stop action at the end of timing.

81	Off load	Its action when the controller is in the closed load
82	Test without load	Action when the controller is in test mode and set to "Unload".
83	Test with load	Action when the controller is in test mode and set to "Load".
84	Emergency stop	When this function is active, the generator is emergency stop fuel output.
85	Reserve	
86	Reserve	
87	Reserve	
88	Reserve	
89	AUX1 low level1	When the generator auxiliary 1 sensor value is lower than the setting value of the auxiliary 1 sensor low value 1 and the delay is action when confirmed.
90	AUX1 low level2	When the generator auxiliary 1 sensor value is lower than the setting value of the auxiliary 1 sensor low value 2 and the delay is action when confirmed.
91	AUX1 high level1	When the generator auxiliary 1 sensor value is higher than the setting value of the auxiliary 1 sensor higher value 1 and the delay is action when confirmed.
92	AUX1 high level2	When the generator auxiliary 1 sensor value is higher than the setting value of the auxiliary 1 sensor higher value 2 and the delay is action when confirmed.
93	AUX2 low level1	When the generator auxiliary 2 sensor value is lower than the setting value of the auxiliary 2 sensor low value1 and the delay is action when confirmed.
94	AUX2 low level2	When the generator auxiliary 2 sensor value is lower than the setting value of the auxiliary 2 sensor low value 2 and the delay is action when confirmed.
95	AUX2 high level1	When the generator auxiliary 2 sensor value is higher than the setting value of the auxiliary 2 sensor higher value 1 and the delay is action when confirmed.
96	AUX2 high level2	When the generator auxiliary 2 sensor value is higher than the setting value of the auxiliary 2 sensor higher value 2 and the delay is action when confirmed.
97	ECU water in fuel	The generator action when detects ECU oil into the water.
98	D-Input 1 alarm	D-input 1 is set to "1 user configured", when a warning or fault input is active.
99	D-Input 2 alarm	D-input 2 is set to "1 user configured", when a warning or fault input is active

100	D-Input 3 alarm	D-input 3 is set to "1 user configured", when a warning or fault input is active
101	D-Input 4 alarm	D-input 4 is set to "1 user configured", when a warning or fault input is active
102	D-Input 5 alarm	D-input 5 is set to "1 user configured", when a warning or fault input is active
103	D-Input 6 alarm	D-input 6 is set to "1 user configured", when a warning or fault input is active
104	D-Input 7 alarm	D-input 7 is set to "1 user configured", when a warning or fault input is active
105	Reserve	
106	Reserve	
107	Reserve	
108-111	Reserve	
112	Reserve	
113	Reserve	
114	Mains power supply	When the closing switch on the mains side, and any one phase voltage greater than 110V or any phase current greater than 2A , output effective.
115	Reserve	
116	Reserve	
117	Reserve	
118	Reserve	
119	Fuel high level1	When the generator oil level is higher than the set value of fuel high level 1 and the delay is action when confirmed.
120	Fuel high level2	When the generator oil level is higher than the set value of fuel high level 1 and the delay is action when confirmed

7.6 DEFINE SENSORS

No.	Parameter	Setting range	Preset
6.1	(PRES. Sensor 1		
6.2	PRES. Sensor 2		
6.3	TEMP. Sensor 1		
6.4	TEMP. Sensor 2		
6.5	Fuel Level Sensor		

Menu descriptions:

PRES. Sensor 1

I Corresponds to the “configurable 2” in the “LOP Sensor type”.

PRES. Sensor 2

I Corresponds to the “configurable 3” in the “LOP Sensor type”.

TEMP. Sensor 1

I Corresponds to the “configurable 2” in the “HET Sensor type”.

TEMP. Sensor 2

I Corresponds to the “configurable 3” in the “HET Sensor type”.

Fuel Level Sensor

I Corresponds to the “configurable 2” in the “Fuel level sensor selection”.



NOTE:

I “Configurable sensor data” means user can input the data manually according to the sensor curve. When configuring, please input the “resistance - measured value” from small to big one by one as following

PRES. Sensor 1

Fix Point	1	2	3	4	5	6	7	8	9	10
Resistance	228.6	261.9	285.7	309.5	338.1	366.7	395.2	419.0	447.6	476.2
Measured	0.0	0.5	1	1.5	2	2.5	3	3.5	4	4.5

PRES. Sensor 2

Fix Point	1	2	3	4	5	6	7	8	9	10
Resistance	152	273	456	638	759	881	1002	1124	1245	1367
Measured	0.0	0.6	1.5	2.4	3.0	3.6	4.2	4.8	5.4	6.0

TEMP. Sensor 1

Fix Point	1	2	3	4	5	6	7	8	9	10
Resistance	7.0	17.0	24.0	30.0	40.0	58.0	80.0	110.0	140.0	210.0
Measured	140	120	110	100	90	80	70	60	50	40

TEMP. Sensor 2

Fix Point	1	2	3	4	5	6	7	8	9	10
Resistance	15.6	18.9	23.1	30.0	43.7	65.0	110.0	160.0	240.0	240.0
Measured	120	113	105	95	85	75	60	50	40	40

Fuel Level Sensor

Fix Point	1	2	3	4	5	6	7	8	9	10
Resistance	1.7	7.0	12.0	17.0	24.0	30.0	38.0	50.0	63.0	106.0
Measured	100	90	80	70	60	50	40	30	20	1

7.7 ATS CONTROL

No.	Parameter	Setting range	Preset
7.0	Quit		
7.1	M V-monitor type	0 ph-ph /1 ph-n	1
7.2	M V low alarm	20 to 200% / Not used	90%
7.3	M V low Return	20 to 200% / Not used	95%
7.4	M V High alarm	20 to 200% / Not used	115%
7.5	M V High Return	20 to 200% / Not used	110%
7.6	M Hz low alarm	10.0 to 500.0Hz / Not used	45.0Hz
7.7	M Hz low Return	10.0 to 500.0Hz / Not used	48.5Hz
7.8	M Hz High ALM	10.0 to 500.0Hz / Not used	57.0Hz
7.9	M Hz High Return	10.0 to 500.0Hz / Not used	52.0Hz
7.10	M alarm delay	0 to 9999s	5s
7.11	M on delay	0 to 9999s	5s
7.12	Transfer time	0 to 600s	0s
7.13	MCB close		
	Function	0 N /1 Y	0
	Delay	0 to 999S	5s
	ALM. class	0 to 6	2
7.14	MCB open		
	Function	0 N /1 Y	0
	Delay	0 to 999s	5s
	ALM. class	0 to 6	2
7.15	Current type	0 GEN./1LOAD	0
7.16	Prohibit return	0 N /1 Y	0
7.17	M fail G to load	0 MAN/1 AUTO	0
7.18	M KW over alarm	20 to 200% / Not used	120%
7.19	M KW o-ALM.delay	0 to 9999s	5s
7.20	M KW o-ALM.ACT.	0 Warning / 1 Electrical trip	0
7.21	M A over alarm	20 to 200% / Not used	115%
7.22	M A o-ALM.delay	0 to 9999s	5s
7.23	M A o-ALM.ACT.	0 Warning / 1 Electrical trip	0
7.24	M normal type	0 to 4	0
7.25	AMF mode	0 to 1	1

**NOTE:**

I All of the above parameters is only supply for GM6651

Menu descriptions:**M V-monitor type**

- I Used to select the controller based on phase - phase voltage or phase - zero voltage as mains voltage monitoring object.
- I In different voltage input type, select "phase - phase" or "phase - zero", voltage monitoring, as following table:

Voltage type \ pam	Ph-Ph	Ph-N
“Y” 3P4W	$V_{L1-L2}, V_{L2-L3}, V_{L3-L1}$	$V_{L1-N}, V_{L2-N}, V_{L3-N}$
“ Δ ” 3P4W	$V_{L1-L2}, V_{L2-L3}, V_{L3-L1}$	$V_{L1-N}, V_{L2-N}, V_{L3-N}$
3P3W	$V_{L1-L2}, V_{L2-L3}, V_{L3-L1}$	
2P3W	V_{L1-L2}	V_{L1-N}, V_{L2-N}
1P2W		V_{L1-N}

M V low alarm

- I Used to define mains low voltage alarm value, the Mains-V low alarm is inactive when parameter configured as “not used”.
- I Expressed by percentage, use “Rated ph-voltage” as the base.
- I Controller will measure phase - zero voltage or phase - phase voltage and compared with the set value. When measuring the voltage value is lower than " rated voltage value " * " mains voltage fault value, and has not been higher than "rated voltage value "*" mains voltage return value, duration greater than "mains failure confirm time", that is mains low voltage alarm value;

M V low Return

- I Used to define the Mains low voltage fault recovery value.
- I Expressed by percentage, use “Rated ph-voltage” as the base.
- I Controller will measure phase - zero voltage or phase - phase voltage and compared with the set value. When the voltage value of measure is higher than " rated voltage value "*" mains voltage return value, the mains voltage failure to confirm time timing reset, the mains is restored to normal.

M V High alarm

- I Used to define Mains high voltage alarm value, the Mains-V high alarm is inactive when parameter configured as “not used”;
- I Expressed by percentage, use “Rated ph-voltage” as the base.
- I Controller will measure phase - zero voltage or phase - phase voltage and compared with the set value. When measuring the voltage value is higher than " rated voltage value "*" mains voltage fault value, and has not been lower than "rated voltage value "*" mains voltage return value, duration greater than "mains failure confirm time", that is mains high voltage alarm value.

M V High Return

- I Used to define the Mains high voltage fault recovery value.
- I Expressed by percentage, use “Rated ph-voltage” as the base.
- I Controller will measure phase - zero voltage or phase - phase voltage and compared with the set value. When the voltage value of measure is lower than " rated voltage value "*" mains voltage return value, the mains voltage failure to confirm time timing reset, the mains is restored to normal.

M HZ low alarm

- I Used to define Mains low frequency fault value, the Mains-Hz low alarm is inactive when parameter configured as “not used”.
- I The measure frequency of the controller will compared with the set value, when voltage frequency value of measure is lower than the set value, and always not over than" low frequency of mains return value ", and the duration greater than "mains fault confiem time", that is mains low frequency fault.
- I The parameter setting is compatible with 400 Hz intermediate frequency system, 50/60Hz system reference range for setting.

M Hz low Return

- I Used to define the low frequency of mains fault recovery value.
- I When measuring mains frequency is higher than "mains low frequency return value ", mains low frequency failure to confirm time timing reset, the mains is restored to normal. The parameter setting is compatible with 400 Hz intermediate frequency system, 50/60Hz system reference range for setting.

M Hz High ALM

- I Used to configure Mains high frequency fault value, the Mains-Hz high Alarm is inactive when parameter configured as “not used”.
- I The measure frequency of the controller will compared with the set value, when voltage frequency value of measure is higher than the set value, and always not under than" high frequency of mains return value ", and the duration greater than "mains fault confiem time", that is mains high frequency fault.
- I The parameter setting is compatible with 400 Hz intermediate frequency system, 50/60Hz system reference range for setting.

M Hz High Return

- I Used to define the high frequency of mains fault recovery value.
- I When measuring mains frequencies below " high frequency of mains return value", so that the mains low frequencies failure to confirm time timing reset, the mains is restored to normal. And the parameter setting is compatible with 400 Hz intermediate frequency system, 50/60Hz system reference range for setting.

M alarm delay

- I Used to define the confirmation of mains failure time.

**NOTE:**

- I When the mains voltage is lower than 10% of the rated voltage, mains failure is confirm immediately, and not need the time to confirm mains failure.

M on delay

I Used to define the delay time from the mains voltage to mains closing relay closure outputs.

Transfer time

I Achieve delay some time to transition to the mains side after the mains was recover and GEN opening.

MCB close

I The controller can monitoring the load switch closing of power generation, for users to choose warning fault shutdown and control. If you select 1/2/3 alarm level when protection function triggered, LCD displays "!W:MCB closing "; If you select 4/5/6 alarm level when protection function triggered, LCD displays "!A:MCB closing".

Function	Select "Y", the monitoring function is active; Select "N", the monitoring function is invalid.
Delay	When the controller sends mains closing command, the delay timer starts timing, in time out, the mains load switch has not closing or in the state of keep mains closing command, switch is opened, the define operation of alarm levels are triggered.
Alarm levels	Used to define the protection is triggered, and what is the controller will do. Details refer to the alarm level configuration table.

MCB open

I Controller can monitoring the load switch tripping of power generation, for users to choose warning fault shutdown and control. If you select 1/2/3 alarm level when protection function triggered LCD display "!W:MCB open "; If you select 4/5/6 alarm level when protection function triggered, LCD displays "!A:MCB open".

Function	Select "Y", the monitoring function is active; Select "N", the monitoring function is invalid.
Delay	When the controller sends mains OPEN command, the delay timer starts timing, in time out, the mains load switch has not tripping or in the state of mains not closing command, switch is closed, the define operation of alarm levels are triggered.
Alarm levels	Used to define the protection is triggered, and what is the controller will do. Details refer to the alarm level configuration table.



NOTE:

- I Make the mains closing and opening monitoring functions effectively, it is necessary to satisfy follow condition at the same time:
- I One of relay is defined as "mains closing / opening";
- I One of D-input is defined as "mains closed auxiliary contacts.

Current type

I The CT can be mounted on the generator output terminal or the load terminal of transfer switch, this menu for two types of selection.

Prohibit return

- I When the configure value is "0", the controller is in the automatic mode of operation, after a mains failure, the generator start running and power supply. When the mains is restored normal, the mains switch closing timer starts timing, time out, the power generation opening, Mains closing supply power, and the generator cooling shutdown, in standby.
- I When the set value is "1" , the controller is in the automatic mode of operation, when the mains failure, the generator start running and power supply. When the mains is restored to normal, the generator still keep start running and power supply, the LCD displays: "limit return". Until the following happens:
 - Ø Change "automatic" to "manual" mode, through manually closing make the mains power supply, then change "manual" to "automatic" mode, you can restore the mains supply power state in the automatic mode.
 - Ø Power generation supply power, fault shutdown occurs, if the mains is normal, then the mains opening, Mains closing supply power.

M fail G to load

- I Use to set controller working in manual operation mode, mains supply power normal , the working conditions of power generation.
- I When the generator manually open and running, in mains failure, the parameter is set to "0", power generation continues to unload operation; When the parameter is set to "1", the controller issued power generation closing command, the Gen power supply after the end of the timing of the Gen power supply delay, , and has maintained this status ignore mains return to norma whether or not t, unless the generator shutdown fault occurs.



NOTE:

- I The controller in manual operation mode, mains failure, the generator does not automatically start running.
- I In this case, Because of mains failure caused by Gen supply, Gen supply state keep continuously.

M KW over alarm

- I Used to define the fault level of mains active power overrun. When the parameter is set to "not used", the mains overload fault protection function is invalid.
- I Expressed by percentage, with "rated active power" as the base.
- I The controller will measure the active power of the mains load compared with the set value, when the load active power value is higher than the "rated active power" * "mains overload fault value", and the duration is greater than "mains overload fault delay ", Then the mains overload fault.

M KW o-ALM delay

- I Used to define the effective time to confirm the mains overload fault.

M KW o-ALM. ACT.

- I Used to set the action that the controller will follow when confirming the mains overload fault.
- I There are two types of parameters that can be set: 0 warning / 1 gas trip.
- I When the parameter is set to "0", the mains overload fault, the controller warning indicator light, alarm buzzer, has been defined as "mains overload" relay closed output, LCD screen display: "! W: overload".

- I When the parameter is set to "1", the mains overload fault, the controller fault indicator light, alarm buzzer ring, city gate, has been defined as "mains overload" relay closed output, LCD screen display: !A: electricity overload. " The fault status is locked until pressed the "Reset" key.

M A over alarm

- I Used to define the level of failure of the mains load current limit. When the parameter is set to "not used", the mains overcurrent fault protection function is invalid.
- I Expressed by percentage, with "rated active power" as the base.
- I The controller measures the three-phase current of the mains load compared to the setting value. When the phase current of the three-phase current is higher than the "rated current" * "mains overcurrent fault value" and the duration is greater than the "mains overcurrent fault delay", the mains overcurrent fault.

M A o-ALM. delay

- I Used to define the effective time to confirm the mains overcurrent fault.

M A o-ALM. ACT.

- I Used to set the action that the controller will follow when confirming the mains overcurrent fault.
- I There are two types of parameters that can be set: 0 warning / 1 gas trip.
- I When the parameter is set to "0", the mains overcurrent fault, the controller warning indicator light, alarm buzzer, has been defined as "mains over current" relay closed output, LCD screen display: "!W: Mains overcurrent ".
- I When the parameter is set to "1", the mains overload fault, the controller fault indicator light, alarm buzzer ring, the city gate, has been defined as "mains overcurrent" relay closed output, LCD screen display: "Failure: electricity over flow". The fault status is locked until pressed "Reset" key.



NOTE:

- I The mains overload and overcurrent protection functions of the controller are valid only when the current input type parameter is set to "1", that the current transformer is mounted on the load side.
- I Because of overload or over-current fault to trigger the mains opening, fault state lock, the generator will not automatically start running by electricity failure, scheduling and external signal sources and other factors.

M normal type

- I Used to setting the different of lost phase status of Mains.

Type \ parameter	Describe	
"0" A-3P4W	A phase must be has power	3 phase must be have power
"1" A-2P4W		B、C can lost anyone phase
"2" A-1P4W		B、C can lost phase at the same time
"3" 2P4W	A phase can be not power	Can lost anyone of 3 phase
"4" 1P4W		Can lost 2 phase of 3 phase

AFM mode

- I Used to setting controller with mains detection and judgment.
- I When set to "1", the realization of electricity measurement and automatic control; when set to "0", no testing, no display Mains parameters.

7.8 SCHEDULER

No.	Parameter	Setting range	Preset
8.1	DATE/ TIME	YY-MM-DD HH:MM:SS	
8.2	Scheduler period	1 to 52 week	1
8.3	1st Scheduler mode	0 Unload/1 load	Unload
8.4	1st Start time		HH:MM
8.5	1st Run duration	1 to 1440min	60
8.6	1st MON active	0 N/1 Y	0
8.7	1st TUE active	0 N/1 Y	0
8.8	1st WED active	0 N/1 Y	0
8.9	1st THU active	0 N/1 Y	0
8.10	1st FRI active	0 N/1 Y	0
8.11	1st SAT active	0 N/1 Y	0
8.12	1st SUN active	0 N/1 Y	0
8.13	2nd Scheduler mode	0 Unload/1 load	Unload
8.14	2nd Start time		HH:MM
8.15	2nd Run duration	1 to 1440min	60
8.16	2nd MON active	0 N/1 Y	0
8.17	2nd TUE active	0 N/1 Y	0
8.18	2nd WED active	0 N/1 Y	0
8.19	2nd THU active	0 N/1 Y	0
8.20	2nd FRI active	0 N/1 Y	0
8.21	2nd SAT active	0 N/1 Y	0
8.22	2nd SUN active	0 N/1 Y	0
8.23	Data log period	1 to 9999min /not used	not used

Menu descriptions:

DATE/TIME

- I Used to configure the date / time: YY-MM-DD HH:MM:SS.
- I The date displayed on LCD, the pre-alarm (warning) and alarm events with time stamp.

Scheduler period

- I Used to set the controller of the scheduling function effective time period.
- I "Weeks" as a unit.

Scheduler mode

- I Used for the controller in the scheduling model was activated, what kind of the control function to choose;
- I When you select "unload" controller running in test mode, the generator start running, transfer switch does not convert, that mains continue to supply, generator unload operation; if choose "load" controller running in test mode, the generator start running, the transfer switch is converted, that is power generation supply power.

Start time

- I Used to configure the start time when controller is active in exercise run scheduler.

Run duration

- I Used to configure the duration when controller is active in exercise run schedule, the scheduler mode will be reset after run duration has expired.

MON active

I The cycle of exercise run scheduler is one week. This menu is used to configure the exercise run schedule on Monday active or not.

TUE active

I Used to configure the exercise run schedule on Tuesday active or not.

WED active

I Used to configure the exercise run schedule on Wednesday active or not.

THU active

I Used to configure the exercise run schedule on Thursday active or not.

FRI active

I Used to configure the exercise run schedule on Friday active or not.

SAT active

I Used to configure the exercise run schedule on Saturday active or not.

SUN active

I Used to configure the exercise run schedule on Sunday active or not.

Data log period

I Controller on a regular basis recorded controller all the measurement data and state signals, this parameter is used to set the data records of cycle.

7.9 Send SMS

No.	Parameter	Setting range	Preset
9.1	Telephone 1 NO.	000000000000 / Not used	Not used
9.2	Telephone 2 NO.	000000000000 /Not used	Not used
9.3	Telephone 3 NO.	000000000000 / Not used	Not used
9.4	Power up SMS	0 N/1 Y	0
9.5	Engine start SMS	0 N/1 Y	0
9.6	Engine stop SMS	0 N/1 Y	0
9.7	Mains failure SMS	0 N/1 Y	0
9.8	Mains return SMS	0 N/1 Y	0
9.9	Warn reset SMS	0 N/1 Y	0
9.10	Alarm reset SMS	0 N/1 Y	0
9.11	F-pump ON SMS	0 N/1 Y	0
9.12	F-pump OFF SMS	0 N/1 Y	0
9.13	Shutdown alarm SMS	0 N/1 Y	1
9.14	Warn SMS	0 N/1 Y	1
9.15	Maintenance SMS	0 N/1 Y	0
9.16	Alarms SMS count	1 to 999 times	3
9.17	Alarms SMS period	1 to 999 min	5
9.18	Warn SMS count	1 to 999 times	3
9.19	Warn SMS period	1 to 999 min	5

Menu descriptions:**Telephone 1 NO.**

- I Used to define the mobile phone number which the Text Message will be sent to.
- I There are total 3 mobile phone numbers can be configured.

Telephone 2 NO.

- I With the above.

Telephone 3 NO.

- I With the above.

Power up SMS

- I Used to define the controller in the power-on operation, whether need to SMS to inform changes of state.
- I When the parameter is set to "Yes", the controller is connected to working power, control GPRS module send SMS to inform this state change; When the parameter is set to "No", the controller is connected to working power, not control the GPRS module send to SMS..

Engine start SMS

- I Used to define the controller in the engine start command is issued, whether need to SMS to inform changes of state.
- I When the parameter is set to "Yes", the controller in the engine start command is issued, control GPRS module send SMS to inform this state change; When the parameter is set to "No", controller in the engine start command is issued, not control the GPRS module to send SMS.

Engine stop SMS

- I Used to define the controller in the engine stop command is issued, whether need to SMS to inform changes of state.
- I When the parameter is set to "Yes", the controller in the engine stop command is issued, control GPRS module send SMS to inform this state change; When the parameter is set to "No", controller in the engine stop command is issued, not control the GPRS module to send SMS.

Mains failure SMS

- I Used to define the controller to mains failure, whether need to SMS to inform changes of state.
- I When the parameter is set to "Yes", the controller in the mains failure occurred, control GPRS module send SMS to inform this state change; When the parameter is set to "No", controller in the mains failure occurred, not control the GPRS module to send SMS.
- I This parameter is only supple for GM6651 controller.

Mains returu SMS

- I Used to define the controller to mains return to normal, whether need to SMS to inform changes of state.
- I When the parameter is set to "Yes", the controller in the mains return to normal, control GPRS module send SMS to inform this state change; When the parameter is set to "No", controller in the mains return to normal, not control the GPRS module to send SMS.
- I This parameter is only supple for GM6651 controller.

Warn reset SMS

- I Used to define the controller to warning status return to normal, whether need to SMS to inform changes of state.
- I When the parameter is set to "Yes", the controller in the warning status return to normal, control GPRS module send SMS to inform this state change; When the parameter is set to "No", controller in the warning status return to normal, not control the GPRS module to send SMS.

Alarm reset SMS

- I Used to define the controller to shutdown fault status return to normal, whether need to SMS to inform changes of state.
- I When the parameter is set to "Yes", the controller in the shutdown fault status return to normal, control GPRS module send SMS to inform this state change; When the parameter is set to "No", controller in the shutdown fault status return to normal, not control the GPRS module to send SMS.

F-pump ON SMS

- I Used to define the controller in a defined as pump control relay closure outputs, whether need to SMS to inform changes of state.
- I When the parameter is set to "Yes", the controller in a defined as pump control relay closure outputs, control GPRS module send SMS to inform this state change; When the parameter is set to "No", controller in a defined as pump control relay closure outputs, not control the GPRS module to send SMS.

F-pump OFF SMS

- I Used to define the controller in a defined as pump control relay from closure become open outputs, whether need to SMS to inform changes of state.
- I When the parameter is set to "Yes", the controller in a defined as pump control relay from closure become open outputs, control GPRS module send SMS to inform this state change; When the parameter is set to "No", controller in a defined as pump control relay from closure become open outputs, not control the GPRS module to send SMS.

Shutdown alarm SMS

- I Used to define the controller in shutdown failure occurred, whether need to SMS to inform changes of state.
- I When the parameter is set to "Yes", the controller in shutdown failure occurred, control GPRS module send SMS to inform this state change; When the parameter is set to "No", controller in shutdown failure occurred, not control the GPRS module to send SMS.

Warn SMS

- I Used to define the controller in warning occurred, whether need to SMS to inform changes of state.
- I When the parameter is set to "Yes", the controller in warning occurred, control GPRS module send SMS to inform this state change; When the parameter is set to "No", controller in warning occurred, not control the GPRS module to send SMS.

Maintenance SMS

- I sed to define the controller in trigger the maintenance alarm limit protection, whether need to SMS to inform changes of state.

Alarms SMS count

- I Used to define the controller in shutdown fault occurred , the number of times message send.

Alarms SMS period

- I Used to define the controller in shutdown fault, the time interval of per twice message send.
- I When the shutdown fault counts parameter is set to "1", this parameter is useless.

Warn SMS count

- I Used to define the controller in warning occurred , the number of times message send.

Warn SMS period

- I Used to define the controller in warning, the time interval of per twice message send.
- I When the warning message counts parameter is set to "1", this parameter is useless.

7.10 CALIBRATION MENU

No.	Parameter	Setting range	Preset
10.1	GEN. V1 offset	-9.9% to 9.9%	
10.2	GEN. V2 offset	-9.9% to 9.9%	
10.3	GEN. V3 offset	-9.9% to 9.9%	
10.4	Current I1 offset	-9.9% to 9.9%	
10.5	Current I2 offset	-9.9% to 9.9%	
10.6	Current I3 offset	-9.9% to 9.9%	
10.7	MAINS V1 offset	-9.9% to 9.9%	
10.8	MAINS V2 offset	-9.9% to 9.9%	
10.9	MAINS V3 offset	-9.9% to 9.9%	
10.10	Pressure offset	-9.9% to 9.9%	
10.11	Temperature offset	-9.9% to 9.9%	
10.12	Batt. V offset	-9.9% to 9.9%	
10.13	AUX. sensor1 offset	-9.9% to 9.9%	
10.14	AUX. sensor2 offset	-9.9% to 9.9%	

Menu descriptions:

GEN. V1 offset

- I Used to modify the measured value of GEN Phase 1 voltage.
- I Reference to the Rated ph-voltage.

GEN. V2 offset

- I Used to modify the measured value of GEN Phase 2 voltage.
- I Reference to the Rated ph-voltage.

GEN. V3 offset

- I Used to modify the measured value of GEN Phase 3 voltage.
- I Reference to the Rated ph-voltage.

Current I1 offset

- I Used to modify the measured value of Phase 1 current.
- I Reference to the Rated current.

Current I2 offset

- I Used to modify the measured value of Phase 2 current.
- I Reference to the Rated current.

Current I3 offset

- I Used to modify the measured value of Phase 3 current.
- I Reference to the Rated current.

MAINS V1 offset

- I Used to modify the measured value of Mains Phase 1 voltage.
- I Reference to the Rated ph-voltage.

MAINS V2 offset

- I Used to modify the measured value of Mains Phase 2 voltage.
- I Reference to the Rated ph-voltage.

MAINS V3 offset

- I Used to modify the measured value of Mains Phase 3 voltage.
- I Reference to the Rated ph-voltag.

Pressure offset

- I Used to modify the measured value of LOP sensor.

Temperature offset

- I Used to modify the measured value of HET sensor.

Batt. V offset

- I Used to modify the measured value of battery voltage.

AUX. sensor1 offset

- I Used to modify the measured value of auxiliary sensor #1.

AUX. sensor2 offset

- I Used to modify the measured value of auxiliary sensor #2.

8 Installation Guide

8.1 The cutout dimensional drawing installed on panel as follows:



Cutout dimension: 173mm(W) * 125mm(H) . Dashed box dimensions for the controller.
The controller is fixed by 4 special fittings.

**NOTE:**



- | If the installation of the controller installed directly on the chassis of the generator or other violent vibration of the device, must be installed shock absorber.
- | To ensure that the degree of protection of the installation controller is IP65, the required panel mounting hole size must be strictly enforced.





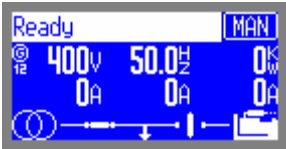
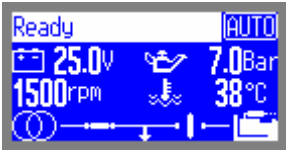
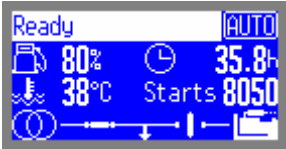
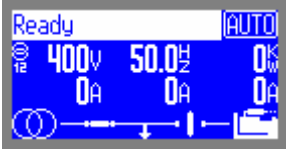
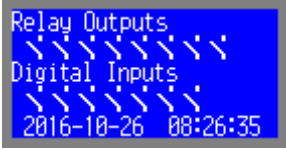

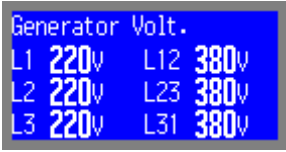
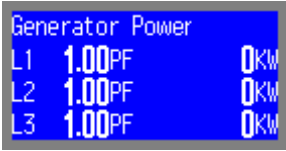
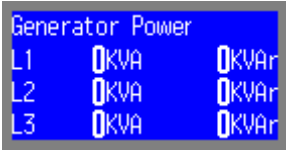
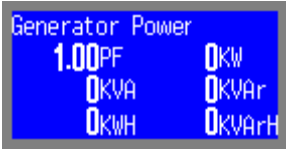
9 LCD displays and Menu System

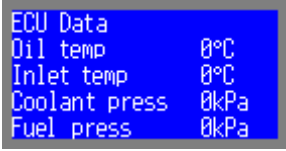
9.1 LCD displays measuring parameters:





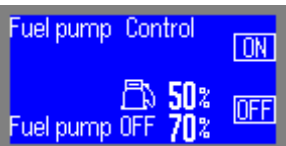

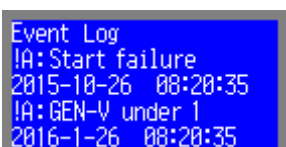



Use a back-light graphic LCD to display data and information. Each LCD screen can display simultaneously plurality of data, uppermost is state information, all the status data nformation displayed by multiple screens, manual press “ can scroll the screen to view the information, the controller can also be set to auto scroll, the timing auto switch the various display screen, (Only the first five pages can auto) , when failure occurs, the LCD immediately shows the fault information in the status bar.

Frist page	Description
	<ul style="list-style-type: none"> Show GEN. L12 line voltage Power frequency Total active power generation load Power load current of each phase
Second page	Description
	<ul style="list-style-type: none"> Engine speed Battery voltage Engine oil pressure, do not use pressure sensors, this project is not displayed Engine coolant temperature when the temperature sensor is not used, this project is not displayed
Third page	Description
	<ul style="list-style-type: none"> This page shows the measured value of the oil level sensor. Cumulative running time of the engine Cumulative number of engine cranking.
Four page	Description
	<ul style="list-style-type: none"> Displays the Mains L12 line voltage Mains frequency Mains total power load Mains load current of each phase
Five page	Description
	<ul style="list-style-type: none"> This page shows the state of controller digital inputs and relay outputs.











Six page	Description
	<ul style="list-style-type: none"> This page shows the generator phase voltage, line voltage.
Seven page	Description
	<ul style="list-style-type: none"> This page show the GEN. of the three-phase active power and power factor.
Eight page	Description
	<ul style="list-style-type: none"> This page show the GEN. of three-phase power apparent power and reactive power.
Nine page	Description
	<ul style="list-style-type: none"> This page shows the total apparent power, total active power, total reactive power and average power factor. Power generation active power and reactive power.
Ten page	Description
	<ul style="list-style-type: none"> This page shows the to maintain preset time and remaining hours. When the maintenance monitoring function is set to "No", this page is not displayed.
Eleven page	Description
	<ul style="list-style-type: none"> These parameters from the engine ECU, that the engine type is not set as "ECU", ECU shows automatically hidden. Display parameters the ECU necessary support, otherwise it does not show the parameters.

Twelfth page	Description
	<ul style="list-style-type: none"> I This page shows each phase of the mains voltage, line voltage. I Display only for GM6651.
Thirteen page	Description
	<ul style="list-style-type: none"> I This page show the Mains of the three-phase active power and power factor. I Display only for GM6651, current input type parameters need to be set to "load" and the mains power supply at the time, this page will be displayed
Fourteen page	Description
	<ul style="list-style-type: none"> I This page shows the mains of the three-phase apparent power and reactive power. I Display only for GM6651 current input type parameters need to be set to "load" and the mains power supply at the time, this page will be displayed.
Fifteen page	Description
	<ul style="list-style-type: none"> I This page shows the total apparent power, total active power, total reactive power and average power factor. I Main active power and reactive power. I Display only for GM6651 current input type parameters need to be set to "load" and the mains power supply at the time, this page will be displayed.
Sixteen page	Description
	<ul style="list-style-type: none"> I This page shows the fuel pump control information
Seventeenth page	Description
	<ul style="list-style-type: none"> I This page displays information such as version control
Eighteenth page	Description
	<ul style="list-style-type: none"> I This page display the controller fault content of recent

9.2 Setting running parameter











Parameter settings are modified by increment or decrement, press and hold on any page  button 2sec to enter into setting state, then press  or  to scroll page in the same menu list, press  enter into submenu, need to modify the parameters first enter to menu 1.2 "password" enter the permission password to modify; or select the items to be modified, press  enter to menu to modify mode, press  or  to changes, when prompted for password 0 0 0 , At this time can press  or  enter the password, set the password value to 1111 and then press  confirm entry, modify the parameters. Otherwise re-prompt for a password. After changing the parameters, press and hold  for 2seco quit parameter settings mode.

FOR EXAMPLE: (SETTING CT RATIO AT 500: 5, THEN CT SHOULD BE CONFIGURED AS 500)







Operation	Description
Press and hold  2sec, enter into parameters setting menu, then LCD displays	[SETTING] 0. QUIT 1. SYSTEM 2. GENERATOR 3. ENGINE
Press  once, press  6 times again, then press  once, LCD displays:	[CT ratio] 1000: 5
Press  or  prompted enter password, the modify password is: 1111, press  to enter.	[CT ratio] Password: 0000
Press  or  to change parameters, this time modified to 500, LCD then display:	[CT ratio] 500: 5
Press  to confirm, then press and hold  2sec quit settings mode, LCD then display:	Ready

FOR EXAMPLE: (SETTING CONTROLLER CRANK ATTEMPT AT 2)

Operation	Description
Press and hold  2sec, enter into parameters settings menu, then LCD displays:	[SETTING] 0. QUIT 1. SYSTEM 2. GENERATOR 3. ENGINE

<p>Press “” 2 times and then press “”, then LCD displays:</p>	<p>[ENGINE] 0. QUIT 1.ENGINE TYPE 2.ECU TYPE 3.ENGINE RUN SPEED</p>
<p>Press “” 9 times and then press “” LCD displays:</p>	<p>[Crank attempt] 3</p>
<p>Press “” or “” prompted enter password: 1111, press “” to enter.</p>	<p>[Crank attempt] Password:0000</p>
<p>Press “” or “” to change parameters, change at 2</p>	<p>[Crank attempt] 2</p>
<p>Press “” to confirm, press and hold “” 2sec will quit parameter settings menu, LCD displays:</p>	<p>Ready</p>

Example: (the parameters of the controller reverts to the factory default values)

<p>Press and hold “” 2sec, enter into parameters settings menu, then LCD displays:</p>	<p>[SETTING] 0. QUIT 1. Parameters 2. GENERATOR 3. ENGINE</p>
<p>Press “” button and then press “” 3 times, then LCD displays:</p>	<p>[SYSTEM] 16. CB closed pulse 17. Reset to Man 18. Default settings 19. Online update</p>
<p>Press “” button, prompted enter password: 1111, press “” button to confirm after entering password.</p>	<p>[Default settings] Password:0000</p>
<p>Press “” to default settings, press and hold “” 2sec will quit parameter settings menu.</p>	<p>[SYSTEM] DONE</p>

Example: (CONFIGURE CONTROLLER AS ONLINE PROGRAM MODE)

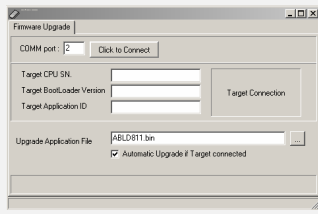
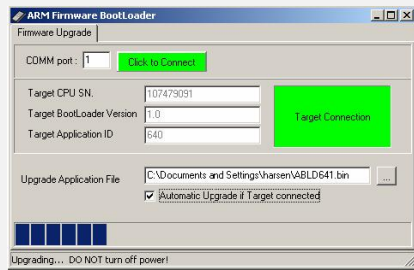
操作	描述
<p>Open the programming software "ABLDs.exe" on your computer, such as the right to import the upgrade process, the controller connected to the computer via cable Minu USB, the computer will recognize the serial port software to fill "COMM port", but do not open the serial port, as following methods to enter programming mode.</p>	
<p>Press and hold "▶" 2sec, enter into parameters settings menu, then LCD displays:</p>	<p>[SETTING] 0. QUIT 1. Parameters 2. GENERATOR 3. ENGINE</p>
<p>Press "▶" button, then press ▲ 2 times, LCD displays:</p>	<p>[SYSTEM]] 16. CB closed pulse 17. Reset to Man 18. Default settings 19. Online update</p>
<p>Press "▶" button, prompted enter password: 2222, then press "▶" to confirm</p>	<p>[Default settings] Password:0000</p>
<p>Press "▶" to confirm enter the programming mode, then the controller LCD disappears, later click computer software "ABLDs.exe" serial port "Click to Connect", then it will automatically upgrade.</p> <p>In this mode it must ensure that the normal power supply, communication line connection will not be interrupted, restart the controller to work after a successful upgrade program.</p> <p>If the operation failure, you can disconnect the power and try again.</p>	

10 Technical Specification

10.1 AC voltage:

Type	True RMS
Phase voltage	15 to 346VAC
Line voltage	25 to 600VAC
Max power wastage per line	<0.1W
Accuracy	1%
Display	0 to 600KV

10.2 AC voltage frequency:

Frequency	3 to 70Hz (voltage \geq 15VAC)
Accuracy	0.1%
Display	0 to 100Hz

10.3 Current (isolated):

Measurement	True RMS
Measuring current	5A
Accuracy	1%
Display	0 to 30000A
Max power wastage per line	<0.01W

10.4 Power supply:

Voltage range	12V/24V (8-35V) continuous
Max. operating current	@12V 150mA, @24V 75mA
Max. standby current	@12V 60mA, @24V 30mA
Cranking drop outs	As before cranking voltage \geq 10V, can be maintained 80 ms at 0V, after the voltage is restored, the controller can work without to install additional auxiliary power.
Accuracy	1%
Display	0 to 40V

10.5 D-input:

Quantity	7
Max. contact resistance	5K Ω
Types	Isolation
Max. contact current per line	1mA

10.6 Configurable relay outputs

Quantity	8
Relay	3A/30Vdc

10.7 Charge failure input

Voltage range	0 to 35Vdc
Accuracy	1%
Max output current	@12V 200mA , @24V 400mA

10.8 Analog Inputs

Number	Resistance
Sensor type	10 bits
Resolution	0 to1 KΩ
Range	2% When full scale, except for sensor error
Accuracy	Resistance

10.9 Speed sensor

Voltage range	1 to 70V
Max. frequency	10000Hz
Fly wheel teeth	5 to 300

10.10 Environmental parameters

Operating ambient temperature Standards	-20 to 70°C IEC60068-2-1 and IEC60068-2-2
Storage ambient temperature Standards	-30 to 80°C IEC60068-2-1 and IEC60068-2-2
Humidity Standards	40°C, 93%RH, 96 hours IEC60068-2-30
Electro Magnetic compatibility (EMC) Standards	EN 61000-6-4 and EN 61000-6-2
Vibration Standards	EN 60068-2-6
Shock Standards	EN 60068-2-27
Electrical safety Standards	EN 60950-1
Degrees of protection Standards	IP65(front) IP20 (back) BS EN 60529